

PIECES DETACHEES & ACCESSOIRES



R E M O R Q U E S



SOMMAIRE

<u>Accessoires barque</u>	<u>P. 32</u>	<u>Faisceaux d'alimentation</u>	<u>P. 18</u>
<u>Accessoires bateau à quille</u>	<u>P. 32</u>	<u>Feux</u>	<u>P. 19</u>
<u>Accessoires canoë et optimist</u>	<u>P. 34</u>	<u>Essieux Paillard non freinés</u>	<u>P. 6</u>
<u>Accessoires catamaran</u>	<u>P. 33</u>	<u>Fixations roues jockey</u>	<u>P. 14</u>
<u>Accessoires dériveur</u>	<u>P. 34</u>	<u>Fusées pour raquettes Nautilus</u>	<u>P. 8</u>
<u>Accessoires jet</u>	<u>P. 33</u>	<u>Garde boue</u>	<u>P. 16</u>
<u>Accessoires multirouleurs</u>	<u>P. 31</u>	<u>Identification d'une jante</u>	<u>P. 12</u>
<u>Accessoires pneumatique</u>	<u>P. 32</u>	<u>Pièces d'assemblage</u>	<u>P. 36</u>
<u>Accessoires spéciaux</u>	<u>P. 35</u>	<u>Pièces roues jockey</u>	<u>P. 14</u>
<u>Accessoires treuils autofreinés</u>	<u>P. 22</u>	<u>Pièces suspensions Nautilus</u>	<u>P. 9</u>
<u>Accessoires treuils électriques</u>	<u>P. 26</u>	<u>Rampes d'éclairage</u>	<u>P. 17</u>
<u>Accessoires treuils GOLIATH</u>	<u>P. 24</u>	<u>Rechange attache à inertie type KF</u>	<u>P. 40</u>
<u>Alimentation/Feux à connecteurs</u>	<u>P. 18</u>	<u>Rechanges compatibilité pour essieux</u>	<u>P. 46</u>
<u>Antivol, Cale Roues, Accessoires divers</u>	<u>P. 5</u>	<u>Rechange pour frein Ø200 X 50 type R47</u>	<u>P. 43</u>
<u>Articles caoutchouc</u>	<u>P. 29</u>	<u>Rechange pour frein Ø200 X 50 type R47</u>	<u>P. 44</u>
<u>Attaches à inertie</u>	<u>P. 1-3</u>	<u>Rechange pour frein Ø250 X 40 type R40</u>	<u>P. 45</u>
<u>Attaches et essieux de chariots</u>	<u>P. 4</u>	<u>Rechange pour moyeu 2878532</u>	<u>P. 42</u>
<u>Axes</u>	<u>P. 30</u>	<u>Rechange pour moyeu 2878534</u>	<u>P. 41</u>
<u>Balanciers</u>	<u>P. 30</u>	<u>Rechange pour moyeu W 2914512</u>	<u>P. 43</u>
<u>Batteries</u>	<u>P. 47</u>	<u>Rechange pour moyeu W 3147103</u>	<u>P. 43</u>
<u>Bouchons pour tubes</u>	<u>P. 38</u>	<u>Rechange pour moyeu W 3557502</u>	<u>P. 44</u>
<u>Brides étirées</u>	<u>P. 38</u>	<u>Roues complètes et jantes</u>	<u>P. 11</u>
<u>Butées</u>	<u>P. 28</u>	<u>Roues de chariots</u>	<u>P. 12</u>
<u>Câbles de freins</u>	<u>P. 8</u>	<u>Roues jockey</u>	<u>P. 13</u>
<u>Câbles électriques</u>	<u>P. 18</u>	<u>Roues jockey</u>	<u>P. 14</u>
<u>Cabochons</u>	<u>P. 19</u>	<u>Support feu jet séparé</u>	<u>P. 17</u>
<u>Chambres à air</u>	<u>P. 12</u>	<u>Supports de treuils</u>	<u>P. 27-28</u>
<u>Chandelles</u>	<u>P. 37</u>	<u>Supports</u>	<u>P. 30</u>
<u>Clips</u>	<u>P. 30</u>	<u>Treuils électriques 12 V.</u>	<u>P. 25</u>
<u>Coulisseaux</u>	<u>P. 17</u>	<u>Treuils manuels à sangle GOLIATH</u>	<u>P. 23</u>
<u>Crochets et rotules</u>	<u>P. 15</u>	<u>Treuils manuels à sangle</u>	<u>P. 21</u>
<u>Eclairage et accessoires</u>	<u>P. 20</u>	<u>Tringlerie et accessoires de freins</u>	<u>P. 10</u>
<u>Essieux Paillard freinés</u>	<u>P. 7</u>	<u>Visserie et divers</u>	<u>P. 39</u>

ATTACHE A INERTIE SEMELLE EN V - **KNOTT**

Recul automatique / de 375 à 2000Kg

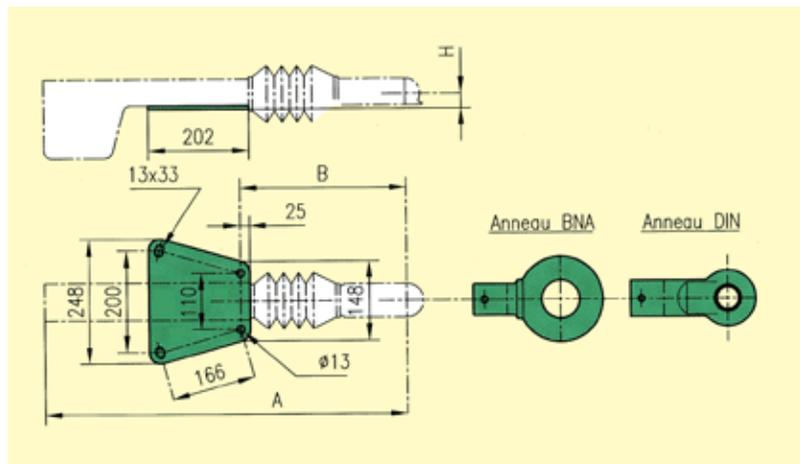

KF7.5C/KF13C/KF20A

Référence	Type	PTAC kg	Charge vert. Kg maxi.	A	B	H	Poids kg
01A1200310	KF 7.5C	375-750	75	650	315	34	14
01A1200311 ⁽¹⁾	KF 13C	750-1300	100	650	315	34	15
01A1200313 ⁽²⁾	KF 20A	1300-2000	110	650	315	34	16

COMPATIBILITES

⁽¹⁾ 651 MF à 1001 MF ⁽²⁾ 1101 MF à 1602 MF

R E M O R Q U E S



1

ATTACHE A INERTIE SEMELLE EN V - **KNOTT**

Recul automatique / de 1400 à 3500 Kg

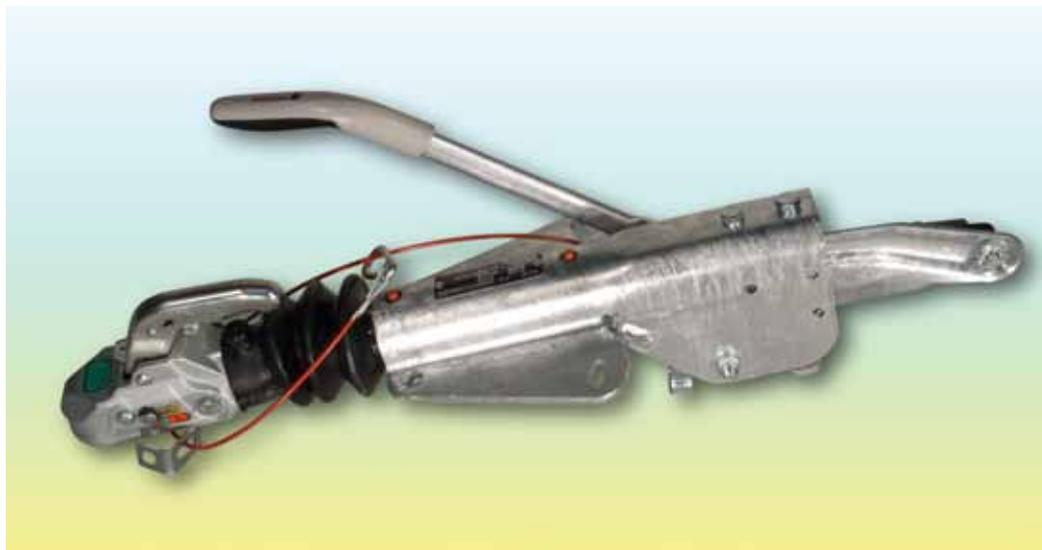

KF 27A



KFG35D

Référence	Type	PTAC kg	Charge vert. Kg maxi.	A	B	H	C	D	E	F	G	Poids kg
01A1200356 ⁽¹⁾	KF 27A	1400-2700	100	666	295	44	100			166	210	19
01A1200338 ⁽²⁾	KFG35D	2700-3500	150	708	302	52,5	120	166	202	207	225	28,5

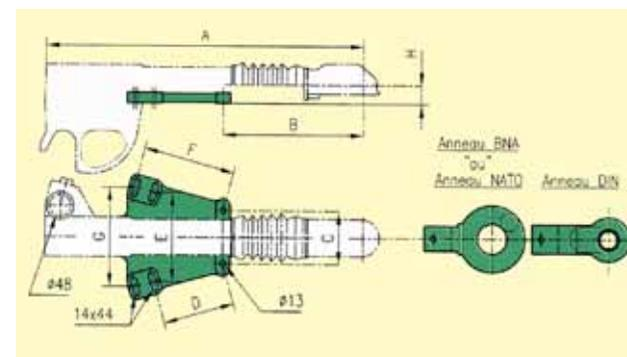

COMPATIBILITES

⁽¹⁾ 1802 MF à 2352 MF ⁽²⁾ 2552 MF à 2903 MF

2 R E M O R Q U E S



ATTACHE A INERTIE TIMON CARRÉ KNOTT

Recul
automatique
de 375
à 2000Kg

KRV 7.5C
KRV 13C
KRV 20A
KNOTT

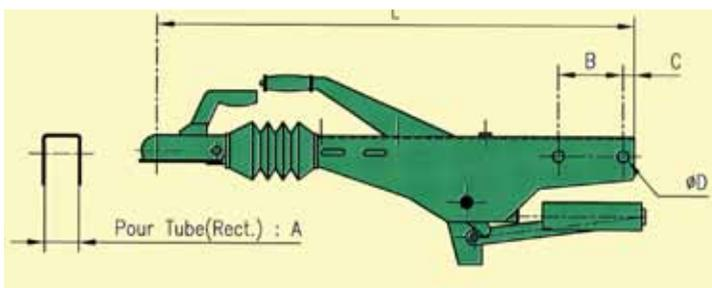
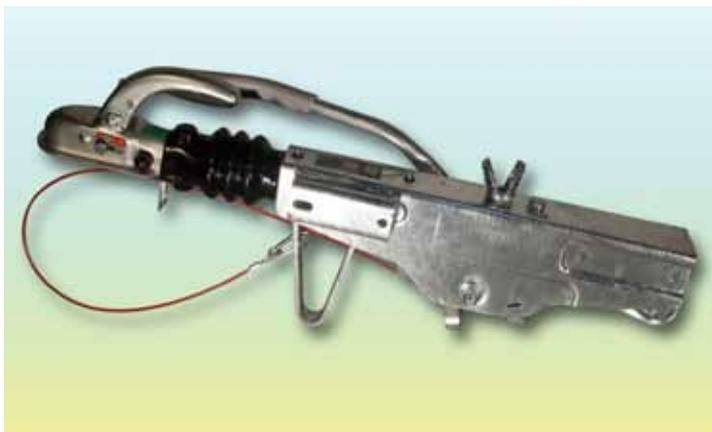

Référence	Type	PTAC kg	Charge vert. Kg maxi.	A	B	C	D	L	Poids kg
01F1200334 ⁽¹⁾	KRV 7.5C	375-750	75	60	120	15	13	814	15
01G1200332	KRV 13C	750-1300	100	70	120	15	13	814	17,5
01G1200333	KRV 20A	1300-2000	100	100	120	20	16,5	810	20

COMPATIBILITES

⁽¹⁾ 501 MF et 551 MF

TETE KNOTT NF POUR TUBE CARRÉ



Référence	Type	PTAC kg	Charge vert. Kg maxi.	Perçage	Fixation tube A	Entraxe			Poids kg
						B	C	D	
09E1200625	K 7.5	750	75	Horiz / vert.	50	90	20	227	1,3
09E1200626 ⁽¹⁾	K 7.5	750	75	Horiz / vert.	60	90	20	227	1,3
09E1200365	K 14	1400	100	Horiz / vert.	50	90	20	227	1,8
09E1200366 ⁽²⁾	K 14	1400	100	Horiz / vert.	60	90	20	227	1,8

COMPATIBILITES

⁽¹⁾ 210 à 551 ⁽²⁾ CH 70 et CH 100

R E M O R Q U E S



ATTACHES ET ESSIEUX DE CHARIOTS



Platine soudée
pour CH 70 et CH 100

Réf. 01 C 1001



Tête SF 3T5 K35
+ fixation en "V"

Réf. 01 C 1002



Tête SF 3T5 K35
+ fixation / c60

Réf. 01 C 1003

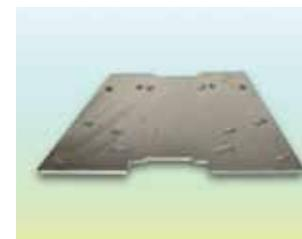

Plaque fixation attache
KF 13 à KF27

Réf. 01 P 1013



Plaque fixation attache
KF 35 et Réf. 01 C 1002

Réf. 01 P 1035



Fusée NF de chariot
4 trous 115 CH 30 à CH 50

Réf. 04 W 3501000



Fusée NF de chariot
4 trous 130 CH 70 à CH 300

Réf. 04 W 3478000

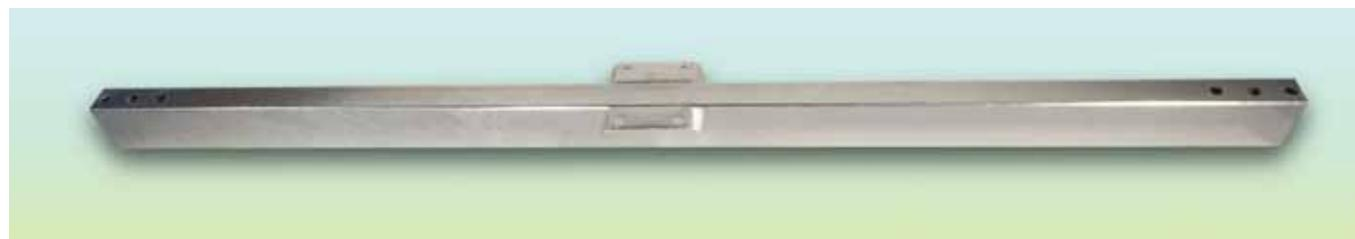

Barre essieu CH 30
80x40x1500

Réf. 04 B 1030

Barre essieu chariots



Type chariot	Section	Longueur	Référence
CH 40 et CH 50	80 x 40	1500	04 B 1040
CH 70	80 x 40	1760	04 B 1070
CH 100 à CH 150 CH 180 en larg. 1580	100 x 50	1900	04 B 1100
CH 180 en larg. 1780 CH 250 et CH 300	100 x 50	2100	04 B 1180

4 R E M O R Q U E S



ANTIVOL - CALE de ROUE - ACCESSOIRES DIVERS



Antivol à cadenas
Réf. 09 P 01700



Boîtier antivol mixte
Réf. 09 P 01800



Serrure antivol	
K 7.5	09 O 1200854
KF 13	09 O 1200805
KF 20	09 O 1200855
KF 27	09 O 1200856
KFG 35	09 O 2122



Bavette* MRE
Réf. 09 D 1001



Cale de roue* MRE
Réf. 09 D 1002



Cale de roue ALKO
Réf. 09 D 1003



Support prise à boulonner
Réf. 09 D 1004



Chaîne de sécurité Lg 450 mm
Réf. 09 D 1005



Support roue de secours**
Réf. 56 T 100



Point de sangle**
Réf. 56 T 200



Broche de casse pour timon
60x60 Réf. 09 D 1060 270 à 401
80x60 Réf. 09 D 1080 501 à 551

* Préciser la couleur - ** Préciser le type de remorque

R E M O R Q U E S



5

ESSIEUX PAILLARD NON FREINES

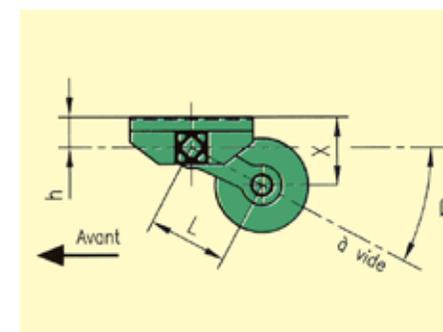
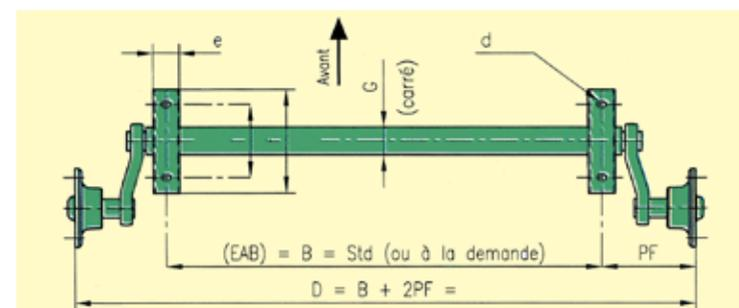

Référence	PTAC kg	Moyeu	EAB mm	PF	i	d	e	f
04 A 3637110 ⁽¹⁾	350	100x4	1100	230	160	13x21	60	225
04 A 3637120	350	100x4	1200	230	160	13x21	60	225
04 W 3223110 ⁽²⁾	550	115x4	1100	165	160	13x21	50	200
04 W 3223120 ⁽³⁾	550	115x4	1200	165	160	13x21	50	200
04 W 3223140 ⁽⁴⁾	550	115x4	1400	165	160	13x21	50	200
04 W 3524110 ⁽⁵⁾	750	130x4	1100	180	160	13x21	50	200
04 W 3524120 ⁽⁶⁾	750	130x4	1200	180	160	13x21	50	200
04 W 3524140 ⁽⁷⁾	750	130x4	1400	180	160	13x21	50	200

COMPATIBILITES

- ⁽¹⁾ Spéciale barque
- ⁽²⁾ 301 jet
- ⁽³⁾ 211 B-D-P-PM-M-4P - 271 AP-D-M-6P-DCH-4C
301 et 351 cata - 331 OPTI 3 et 4
- ⁽⁴⁾ 331 AP-8P-6C-M - 301 PM et 351 PM // PMSR
401 M-CM-PM - OPTI 6-D2
- ⁽⁵⁾ 501 jet
- ⁽⁶⁾ 501 CATA et 551 CATA DOUBLE
- ⁽⁷⁾ 501 M-CM-PM-8C-PMSR-OPTI 6 et 8
551 M-CM-D3-PM-PMSR - 10C

6 R E M O R Q U E S



ESSIEUX PAILLARD FREINES

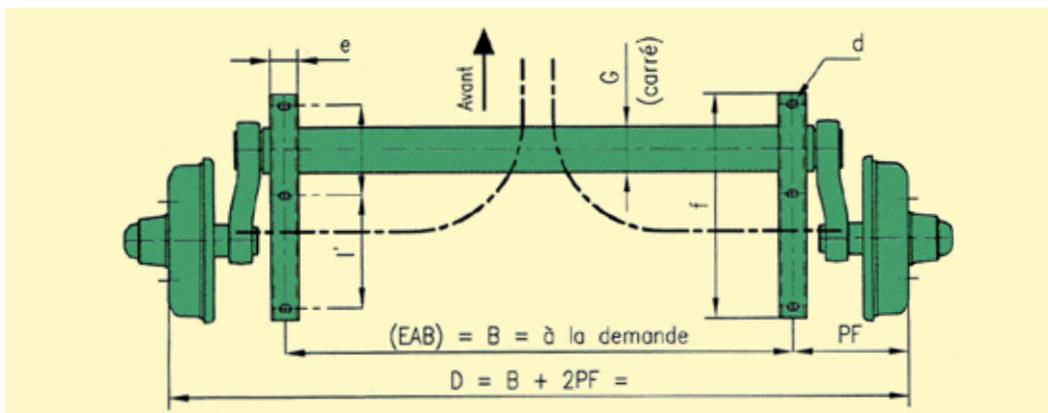

Référence	PTAC kg	Moyeu	EAB mm	PF	i	e	f
04 W 3526R47-140 ⁽¹⁾	750	130x4	1400	215	160	50	225
04 W 3457R47-144 ⁽²⁾	900	130x4	1440	215	160	50	225
04 W 3457R47-164 ⁽³⁾	900	130x4	1640	235	160	50	225
04 W 3458R47-144 ⁽⁴⁾	1300	130x4	1440	215	160	50	225
04 W 3458R47-164 ⁽⁵⁾	1300	130x4	1640	235	160	50	225
04 W 3458R47-184 ⁽⁶⁾	1300	130x4	1840	235	160	50	225
04 W 3463R47-164 ⁽⁷⁾	1500	130x4	1640	235	160	50	400
04 W 3463R40-164 ⁽⁸⁾	1600	130x4	1640	235	160	50	400
04 W 3463R40-184 ⁽⁹⁾	1600	130x4	1840	235	160	50	400
04 W 3472R40-184 ⁽¹⁰⁾	1800	130x4	1840	235	160	50	400

* Essieu livré avec câbles de frein inox

COMPATIBILITES

- ⁽¹⁾ 501 et 551 F
- ⁽²⁾ 651
- ⁽³⁾ 1052 - 1252 - 1452
- ⁽⁴⁾ 701 - 801 - 851
- ⁽⁵⁾ 901 - 1001 - 1602
- ⁽⁶⁾ 1802 - 2052 - 2903
- ⁽⁷⁾ 1101 - 1181
- ⁽⁸⁾ 1301
- ⁽⁹⁾ 2352 - 2552
- ⁽¹⁰⁾ 2802

FUSEES EQUIPEES pour RAQUETTES NAUTILUS



Fusée Non Freinée



Fusée Freinée

Référence	Frein	Diamètre en mm	Perçage	Type remorque
04 W 3292000	non	155	115x4	N210 à N401
04 W 3525000	non	170	130x4	N501 à N551
04 W 3527R47 D/G	oui	200	130x4	N501MF à N551MF
04 W 3645R47 D/G	oui	200	130x4	N651MF à N1101MF N1052MF à N2352MF N2903MF
04 W 3646R40 D/G	oui	250	130x4	N1301MF N2552MF à N2802MF

Fusée freinée vendue avec câble de frein inox

CABLES DE FREIN

Référence	Inox	L	G	d1	d2
20 G 240001	Non	1440	1230	M12x1,5	M8
20 G 2400001 i	Oui	1440	1230	M12x1,5	M8
20 G 2400002	Non	1240	1030	M12x1,5	M8
20 G 2400005	Non	1640	1430	M12x1,5	M8
20 G 2400005 i	Oui	1640	1430	M12x1,5	M8
20 G 2400007	Non	2040	1830	M12x1,5	M8

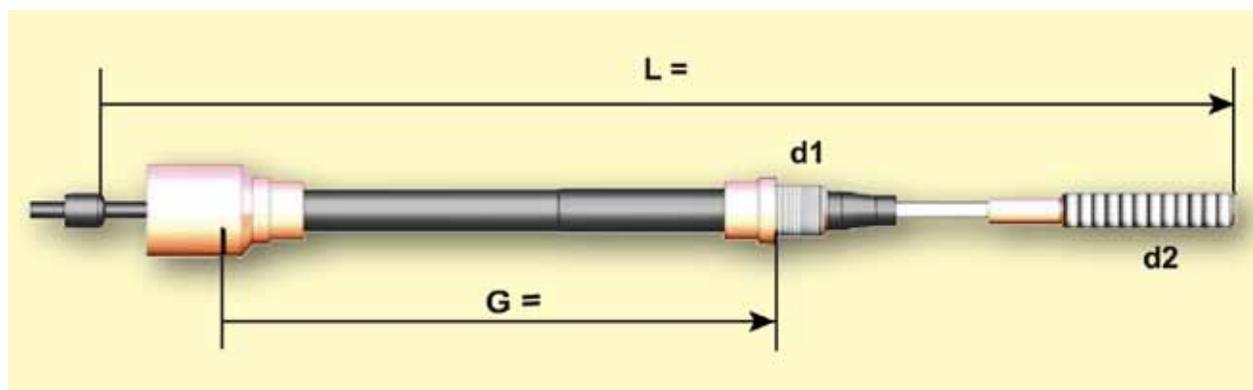

8 R E M O R Q U E S



PIECES POUR SUSPENSIONS REMORQUES NAUTILUS



Désignation	Référence	illustration
Raquette petit modèle pour N 210 à N 551	80 N 265	
Raquette droite grand modèle	80 N 365	
Raquette gauche grand modèle pour N 651 à N 2903	80 N 366	
Axe petit modèle + boulons 14 x 30 N 210 à N 551	80 N 270	
Axe grand modèle + boulons 14 x 30 pour N 651 à N 2903 avant 2003	80 N 380	
Axe grand modèle inox + écrous pour N 651 à N 2903 depuis 2004	80 N 381	
Bague d'axe	80 N 100	

Ressorts			
Ressort noir 80 N 001 ⁽¹⁾	Ressort vert 80 N 004 ⁽⁴⁾	Ressort blanc 80 N 003 ⁽³⁾	Ressort rouge 80 N 002 ⁽²⁾
COMPATIBILITES			
⁽¹⁾ N 210 à N 401 ⁽²⁾ N 1101 à N 1301 - N 1802 à N 2903 ⁽³⁾ N 651 à N 1001 - N 1052 à N 1602 ⁽⁴⁾ N 501 et N 551			
Amortisseur Record 00729	80 N 010		

R E M O R Q U E S



TRINGLERIE et ACCESSOIRES de FREIN



Tiges filetées Ø 10 mm
inox

Référence	Longueur en m
20 T 1500	1,5
20 T 2000	2
20 T 3000	3



Serre câble inox Ø 10
Réf : 20 S 10



Lien support câble de frein
Réf : 20 L 20

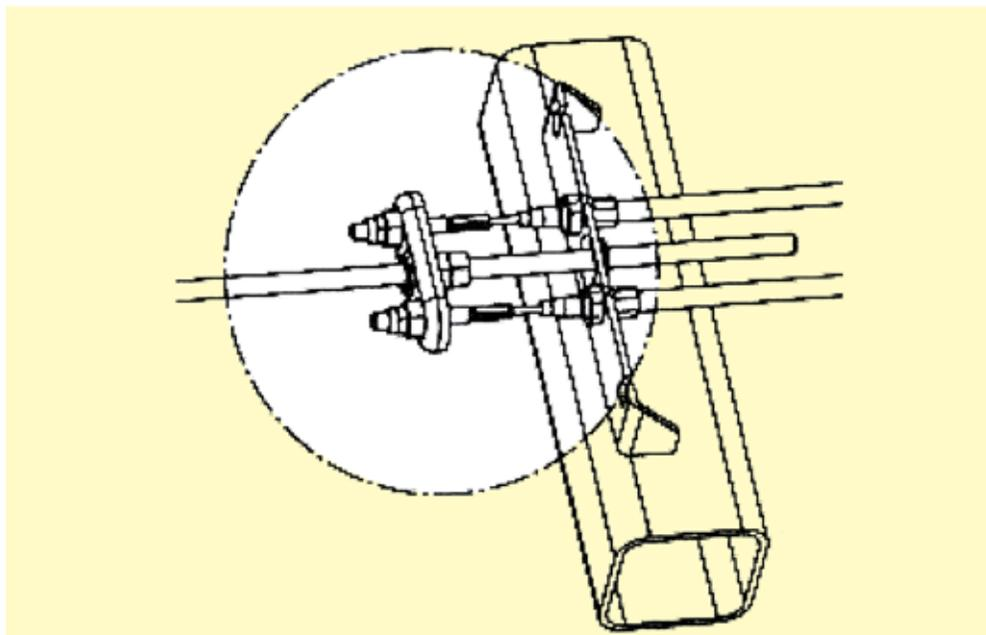

Kit palonnier simple
Réf : 20 T 2057301

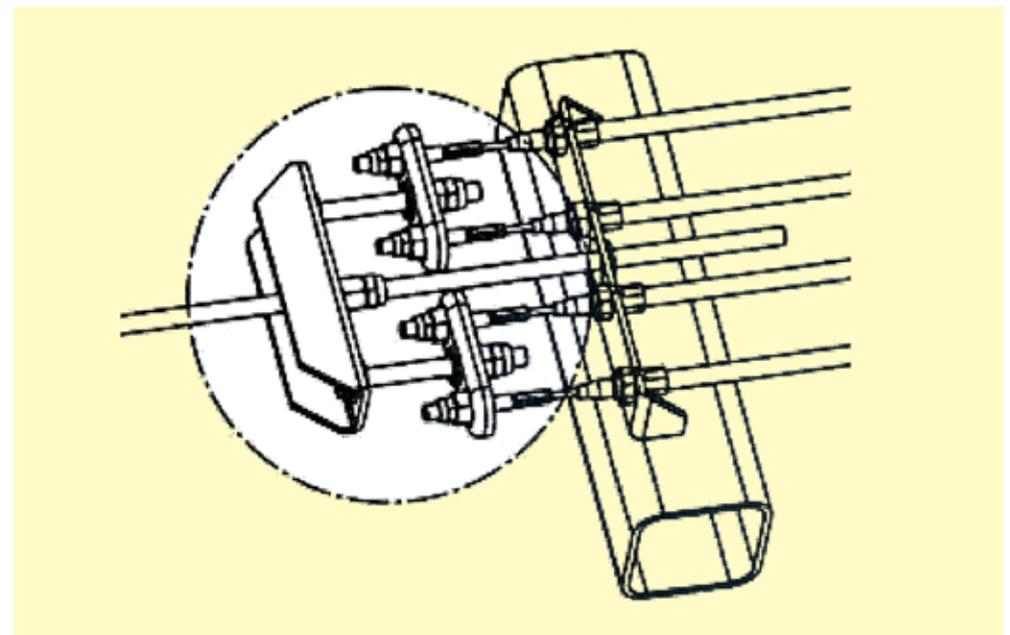

Kit palonnier double
Réf : 20 T 2057302

10 R E M O R Q U E S



ROUES COMPLETES



Désignation	Référence	Force en kg	Bars	Perçage
4.00 - 8	RS 10 ⁽¹⁾	265	2,5	100 X 4 115 X 4
4.50 - 10	RS 15 ⁽²⁾	400	3,5	100 X 4 115 X 4
145 / 70 R 13	RS 20 ⁽³⁾	425	3,2	115 X 4
155 / 70 R 13	RS 25 ⁽⁴⁾	425	3,1	130 X 4
165 / 70 R 13	RS 30 ⁽⁵⁾	450	2,7	130 X 4
165 R 13 C	RS 45 ⁽⁶⁾	710	4,6	130 X 4
185 / 70 R 13	RS 40 ⁽⁷⁾	600	3,1	130 X 4
185 R 14 C	RS 50 ⁽⁸⁾	900	4,6	130 X 4
155 / 70 R 12 C	RS 60 ⁽⁹⁾	900	6,5	130 X 4

JANTES



Désignation	Référence	Perçage	Déport en mm	Pour roue
2.50 X 8	23 120361B	4 X 100	0	400 X 8
2.50 X 8	23 120360B	4 X 115	0	400 X 8
3.50 X 10	23 61060	4 X 100	0	450 X 10
3.50 X 10	23 61059020	4 X 115	0	450 X 10
4.5 J 12 H 2	23 61267001	4 X 130	30	155 / 70 R 12 C
4 J 13 H 2	23 61362016	4 X 115	10	145 / 70 R 13
4 J 13 H 2	23 61362030	4 X 130	20	155 / 70 R 13
4.5 J 13 H 2	23 61367035	4 X 130	20	165 / 70 R 13 165 R 13 C 185 / 70 R 13
5 J 14 H 2	23 61472029	4 X 130	20	185 R 14 C

COMPATIBILITES

⁽¹⁾ RS 10 (4 T 100) Spéciale barque - ⁽²⁾ RS 15 (4 T 100) Spéciale barque (option) - RS 15 (4 T 115) 210 – 270 – 300 – 330
⁽³⁾ 211 – 271 – 301 – 331 – 351 – 401 - ⁽⁴⁾ 501 – 551 - ⁽⁵⁾ 651 – 1052 – 1252 – 1452 - ⁽⁶⁾ 851 - ⁽⁷⁾ 701 – 801 – 1602
⁽⁸⁾ 901 – 1001 – 1101 – 1181 – 1301 – 1802 à 2903

R E M O R Q U E S



ROUES CHARIOT et CHAMBRES à AIR



Désignation	Nombre de plis	Moyeu Ø x Lg	Roulement	Référence	Chambre à air
300 X 4	2 PR	20 X 100	--	31 A 300	25 0003004
400 X 8	2 PR	25 x 100	--	31 A 401	25 0003508
400 X 8	6 PR	30 X 100	(2x) 6006 RS	31 A 400	25 0014008
500 X 8	6 PR	35 X 100	(2x) 6007 RS	31 A 500	25 0015008
600 X 9	10 PR	35 X 70	(2x) 6207 RS	31 A 600	25 0016009

Légende :

A : alésage - **B** : distance entre deux trous consécutifs - **C** : nombre de trous - **D** : déport - **E** : entraxe de perçage en diagonale

G : diamètre jante en pouce - **L** : largeur jante en pouce.

LE DEPORT :

Il s'agit de la distance entre la face d'appui du voile et l'axe fictif séparant la jante en deux parties égales dans le sens de la largeur.

Le déport est dit positif si la face d'appui est du côté extérieur de l'axe fictif

Le déport est dit négatif si la face d'appui est du côté intérieur de l'axe fictif

L'ALEPAGE :

Diamètre du trou central du voile, mesuré côté face d'appui.

L'ENTRAXE :

C'est le diamètre du cercle passant par le milieu des trous de fixation de la roue. Pour le connaître, mesurer la distance entre deux trous côté à côté de centre à centre.

Schéma d'identification d'une jante

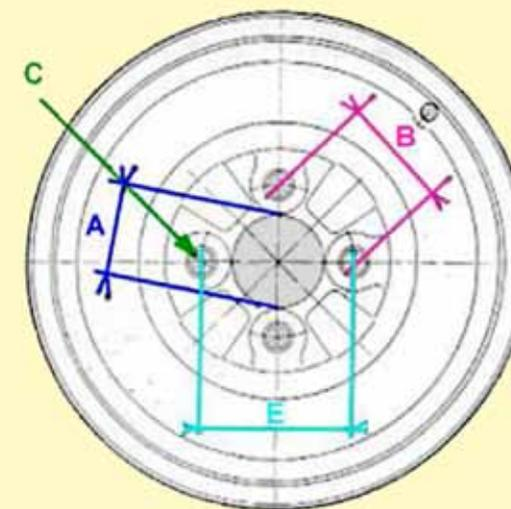
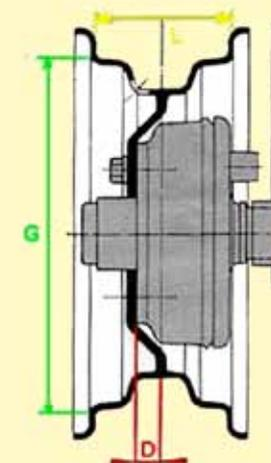

ROUES JOCKEY



Roue jockey Ø 48
standard
34 A 1200218



Roue jockey Ø 48
renforcée
34 C 1200870



Roue jockey Ø 48
annelée
34 C 1200357



Roue jockey Ø 60
standard
34 C 1200220



Roue jockey TP
escamotable
34 C 1200821



Roue jockey Ø 48
gonflable
34 B 1200804

Désignation	Référence	Charge statique kg	Haut mini mm	Course mm	Ø corps mm	Roulette Ø x larg mm
Roue jockey Ø 48 standard	34 A 1200218	100	495	210	48	205 x 30
Roue jockey Ø 48 renforcée	34 C 1200870	150	545	220	48	205 x 30
Roue jockey Ø 48 annelée	34 C 1200357	250	730	220	48	230 x 65
Roue jockey Ø 60 standard	34 C 1200220	150	530	220	60	230 x 65
Roue jockey TP escamotable	34 C 1200821	900	577	300	Carré 70	230 x 65
Roue jockey Ø 48 gonflable	34 B 1200804	100	520	220	48	260 x 85

R E M O R Q U E S



FIXATIONS et PIÈCES ROUE JOCKEY



Collier Ø 48
à boulonner
Réf. 34 D 1200218



Collier Ø 60
à boulonner
Réf. 34 D 1200223



Platine Ø 48 std et renf
à brider
Réf. 34 P 48



Collier fonte + cornière
à brider
Réf. 34 P 60



Poignée collier
à boulonner et brider
Réf. 34 M 01



Collier fonte
seul
Réf. 34 D 1200358



Roulette
205x30
Réf. 34 G 1200348



Roulette
260x85
Réf. 34 G 1200813



Roulette
230x65
Réf. 34 G 1200349

CROCHETS - ROTULES

Rotules divers diamètre 50



ISO 3,5 T

14 A 011



Col de cygne
Sdt 1,5 T

14 A 03



Col de cygne
Maxi 1,5 T

14 A 04



Col de cygne BX-CX
Ral.M16 / 1,5 T

14 A 06



Col de cygne
Démont. 110 1,5 T

14 A 07

Cache rotule plastique



14 C 02

Plaque de réhausse 4 trous

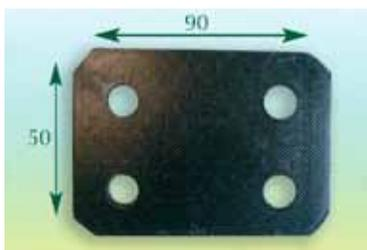

14 B41 REH4

Crochet 34B 8T

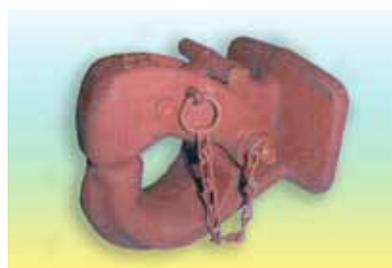

Non percé / 17x90x40

14 D 34B

Plaque de réhausse 6 trous

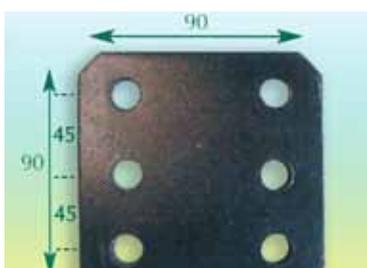

14 B42 REH6

Crochets fixation véhicules tracteurs pour anneaux 68x25 - 68x42 - 76x42 - DIN

HOMOLOGUE
94/20/CE



2 Trous 17x90 - 3T5
14 D 30000C - 32C



4 Trous 17x90x40 - 3T5
14 D 30000K - 32C



Chape à rotule 4 trous
1,5T/3,5T - 17x90x40

14 D CHO30000KB



Chape à rotule 2 trous
1,5T/3,5T - 17x90

14 D CHO30000CB



Axe/clips boule 3T5
Ø24, Lg 18,5

14 D 940001



Chape rotule 3,5T/8T
non percé / 4Tt 90x40

14 D 8215



Axe boule 3T5 pour
chape 8T Ø32

14 D 940002



Clip pour chape 8T

14 D 940006



Kit boule Ø50
Crochet mixte

14 E 930 010



Crochet mixte/Boule 3T5
Ø 50 - 2tr/4tr 17x90x40

14 E CRO30000CB



Crochet attelage Ringfeder
type 601

14 F 601

R E M O R Q U E S



15

GARDE BOUE



Garde boue 8''



Garde boue 10''



Garde boue 13''

Désignation	Dimensions en mm	Coloris	Référence
Garde boue 8'' en polypropylène	500 X 150 X 190	Vert armée	50 SP 8
Garde boue 10 et 13'' en polypropylène	600 X 170 X 245	noir	50 SP 10
Garde-boue 13 et 14'' en polypropylène	760 X 190 X 320	noir	50 SP 13
Garde boue 12 et 13'' + marche pieds en polypropylène *	670 X 200 X 240	Jaune-vert-rouge-gris	50 GP 670
Garde boue 13 et 14'' + marche pieds en polypropylène *	750 X 200 X 350	Jaune-vert-rouge-gris	50 GP 750
Garde boue 12 et 13'' sans marche pieds en polypropylène *	670 X 200 X 240	Jaune-vert-rouge-gris	50 GS 670
Garde boue 13 et 14'' sans marche pieds en polypropylène *	750 X 200 X 350	Jaune-vert-rouge-gris	50 GS 750
Marche pieds seul *	-	Jaune-vert-rouge-gris	50 MP 01



Garde boue + marche pied



Garde boue seul

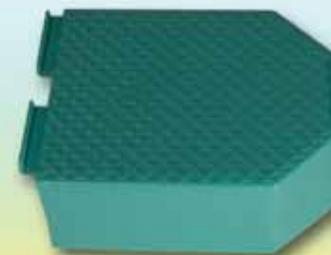

Marche pied

*Préciser la couleur

16 R E M O R Q U E S



RAMPES D'ECLAIRAGES



44 M35 - 44 M 40



44 M55 - 44 M 60

Désignation	Référence	Couleur	Type remorques
Rampe 1,25m écart 600mm	44 M 35	galva	spéciale barque
Rampe 1,25m écart 960mm	44 M 40	galva	301 et 501 jet
Rampe 1,5m	44 M 55	Bandeau noir	210 à 551
Rampe 2m	44 M 60	Bandeau noir	651 à 2903 et remorques cata

COULISSEAUX



59 C 2020 - 59 C 4027 - 59 C 4040



59 CV 4027 - 59 CV 4040

Désignation	Référence	Longueur	Type remorques
Jeu coulisseaux 20 X 20mm	59 C 2020	1,20 m	210 à 331 et 501 ribster
Jeu coulisseaux 40 X 27mm	59 C 4027	1,20 m	501 à 851
Jeu coulisseaux 40 X 40mm	59 C 4040	1,20 m	901 à 2903
Jeu coulisseaux 40 X 27mm coudés	59 CV 4027	2,5 m	651VF à 851 VF
Jeu coulisseaux 40 X 40mm coudés	59 CV 4040	2,5 m	901 VF à 2903 VF

SUPPORT FEU JET SEPARÉ



Droit
Réf. : 59 F 201



Gauche
Réf. : 59 F 202

R E M O R Q U E S



17

FAISCEAUX D'ALIMENTATION



Faisceau 501



Faisceau avant



Faisceau arrière

Désignation	Référence	Longueur
Faisceau 501	45 F 5017	7.0 m
Faisceau avant	45 F 1510	5,1 m
	45 F 1610	6,1 m
Faisceau latéral	45 F 2300	3.0 m
Faisceau arrière	45 F 3680	6,8 m
	45 F 3730	7,3 m
	45 F 3780	7,8 m
	45 F 3980	9,8 m
Faisceau mâle-mâle	45 F 4750	7,5 m



Faisceau latéral



Faisceau mâle-mâle

ALIMENTATION FEU À CONNECTEUR



Longueur 2 x 5 M Réf. 43 F 12065

Longueur 2 x 7 M Réf. 43 F 12067

CÂBLES ELECTRIQUES

	Référence
Câble 2 X1	51 C 300782
Câble 4 X1	51 C 300793
Câble 6 X1	51 C 300894
Câble 7 X1	51 D 300804

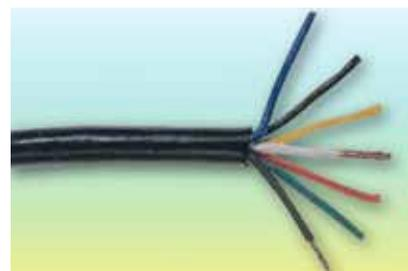

FEUX ET CABOCHONS

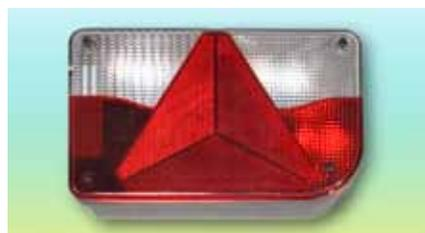

1 Feu 5 fonctions



2 Feu 5 fonctions



3 Feu 5 fonctions



4 Feu 5 fonctions



5 Feu 4 fonctions



6 Feu 4 fonctions



7 Éclaireur de plaque



8 Feu antibrouillard

Repère	Type	Marque	Référence	
			Feu complet	Cabochon
1	Feu 5 fonctions droite (Triangle intégré)	JOKON 06061	43 J 6061110	43 J 6061210
	Feu 5 fonctions gauche (Triangle intégré)		43 J 6061120	43 J 6061220
2	Feu 5 fonctions droite Connecteur rond (Triangle intégré)	JOKON 1206	43 J 1206110	43 J 1206210
	Feu 5 fonctions gauche Connecteur rond (Triangle intégré)		43 J 1206120	43 J 1206220
3	Feu 5 fonctions droite (Triangle intégré)	JOKON 1281	43 J 1281110	43 J 1281210
	Feu 5 fonctions gauche (Triangle intégré)		43 J 1281120	43 J 1281220
4	Feu 4 fonctions droite	DAFA	43 J 0784110	43 J 0784210
	Feu 5 fonctions gauche	0784	43 J 0784120	43 J 0784220
5	Feu 4 fonctions droite	AJ.BA	43 J 5425110	43 J 5425210
	Feu 5 fonctions gauche	5425	43 J 5425120	43 J 5425220
6	Feu 4 fonctions	AJ.BA 50789	43 J 2707084	43 J 2707211
7	Éclaireur de plaque	SACEX 2751	43 F 2751	----
8	Feu antibrouillard	AJ.BA 51305	43 N 2408095	----

ECLAIRAGE ET ACCESSOIRES

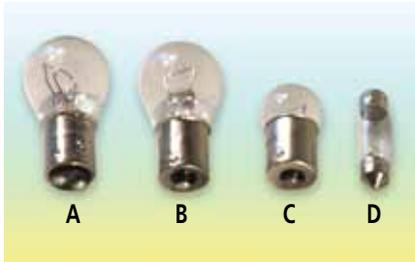

AMPOULES

A 2 plots 12 v-21/5 w réf. 47 M 110118
 B 1 plots 12 v-21 w réf. 47 M 110116
 C Graisseur 12 v-5 w réf. 47 M 110121
 D Navette 12 v-5 w réf. 47 M 110157

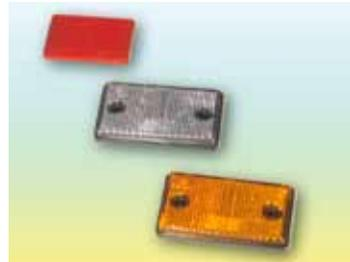

CATADIOPTRE 75 X 45 mm

Blanc réf. 43 D 2855
 Orange réf. 43 D 2856
 Rouge réf. 43 D 2857



PRISE MALE 7 PLOTS

Métal réf. 49 C 300964
 Plastique réf. 49 C 300962



PRISE FEMELLE 7 PLOTS

Métal réf. 49 S 300972
 Plastique réf. 49 S 300967



PRISE 13 PLOTS

Mâle réf. 49 S 300608
 Femelle réf. 49 S 300618



ADAPTATEUR

13 plots mâle/7 plots femelle
 réf. 49 S 300644



FEU GABARIT BLANC 90X45

réf. 43 G 2200600



FEU GABARIT ORANGE 90X45

réf. 43 G 2200601



TRIANGLE ROUGE

réf. 43 O 200331



FEU GABARIT 65X62

réf. 43 G 2203090



FEU GABARIT BICOLORE A POSER

réf. 43 G 30110040

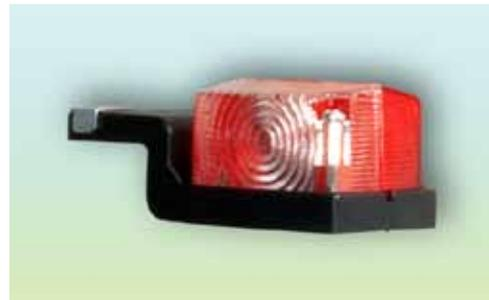

FEU GABARIT BICOLORE A POSER

réf. 43 G 30110140



FEU GABARIT BICOLORE DROIT

réf. 43 G 2200921



FEU GABARIT BICOLORE INCLINE

réf. 43 G 35256000

20 R E M O R Q U E S



TREUILS MANUEL A SANGLE

Série TS Auto freiné



TR 7



TS 700 / TS 800 / TS 900



TS 1200 / TS 1600

	TR 7	TS 700	TS 800	TS 900	TS 1200	TS 1600
Référence	37TR7	37TS700	37TS800	37TS900	37TS1200	37TS1600
Capacité de halage	600 daN	700 daN	800 daN	900 daN	1200 daN	1600 daN
Rapports vitesse 1 vitesse 2		1/3.5 -	1/4.85 -	1/4.35 -	1/4.35 1/9.71	1/4.35 1/9.71
Sangle longueur couleur	6m noire	6m noire	8m noire	8m jaune	8m jaune	8m jaune
Bobine équipée basculeur-sangle-crochet	37BT600	37BT700	37BT800	37BT900	37BT1200	37BT1600
Basculeur seul	-	37BA1000	37BA2000	37BA2000	37BA2000	37BA2000
Carter de protection	-	37CA1000	37CA1000	37CA1000	37CA1000	37CA1000
Longueur manivelle référence	37M7	250mm 37L25	250mm 37L25	290mm 37L29	250mm 37L25	290mm 37L29
Masse du treuil	3,0 Kg	4,5 Kg	5,5 Kg	5,8 Kg	6,3 Kg	6,4 Kg

20 AFD



Référence **37 AF 20**
 Force de halage : 2500 kg
 Nombre de vitesses : 1
 Frein : oui
 Poids indicatif : 7,8 Kg
 Réf. Manivelle : 37 L 30

TPV 2000



Référence **37 T 2000**
 Force de halage : 3000 kg
 Nombre de vitesses : 2
 Frein : oui
 Poids indicatif : 21 Kg
 Réf. Manivelle : 37 L 25

R E M O R Q U E S



ACCESSOIRES TREUILS



MANIVELLE TR 7

Réf. 37 M 7



MANIVELLE TS et TPV

Lg 250 mm réf. 37 L 25
Lg 290 mm réf. 37 L 29



MANIVELLE AFD

Réf. 37 L 30



BOBINE EQUIPEE TR 7

Réf. 37 BT 600



BASCULEUR SEUL

Réf. 37 BA 1000 - Réf. 37 BA 2000



BOBINE EQUIPEE TS

Réf. 37 BT 700 - Réf. 37 BT 800
Réf. 37 BT 900 - Réf. 37 BT 1200
Réf. 37 BT 1600



CARTER DE PROTECTION

Réf. 37 CA 1000

22 R E M O R Q U E S



TREUILS MANUEL A SANGLE

Marque « Goliath »



DL 900



5 à 9N1



16N2



16 et 20N2F



25N3F

	DL 900	5N1	7N1	9N1	16N2	16N2F	20N2F	25N3F
Référence	37V900	37A5	37A7	37A9	37B16	37C16	37C20	37C25
Force de halage	409 kg	575 kg	750 kg	985 kg	1600 kg	1600 kg	1800 kg	2300 kg
Nombre de vitesse	1	1	1	1	2	2	2	3
Sangle longueur	6m	6m	8m	8m	8m	8m	8m	8m
couleur	noire	noire	noire	jaune	jaune	jaune	jaune	jaune
référence	39T0600	39T0600	39T1800	39T2801	39T3800	39T3800	39T3800	39T3800
Frein	non	non	non	non	non	oui	oui	oui
Référence cliquet	37X6290	37SE 00231	37TSE 00232	37TSE 00232	37TSE 00232	37TSE 00232	37TSE 00232	37TSE 00232
Référence manivelle	37W6307	37M11	37M11	37M11	37M12	37M12	37M12	37M12
Masse du treuil	2 kg	3 kg	4,6 kg	6 kg	6,9 kg	7,8 kg	8 kg	13,1 kg

23 R E M O R Q U E S



ACCESSOIRES TREUILS "GOLIATH"



MANIVELLE DL 900
Réf. 37 W 6307



MANIVELLE 5N à 9N1
Réf. 37 M 11



MANIVELLE à RESSORT
Réf. 37 M 14



MANIVELLE à EMBOITER
Réf. 37 M 12



MANIVELLE 6 PANS
Réf. 37 M 13



KIT CLIQUET DL 900
Réf. 37 X 6290



CLIQUET 5N1
Réf. 37 SE 00231



CLIQUET 7N1 à 20N2F
Réf. 37 TSE 00232

Câbles		
Diamètre	Force	Référence
3 mm	571 kg	39 A 9574
4 mm	940 kg	39 B 7190
5 mm	1450 kg	39 D 3440
6 mm	2120 kg	39 E 3957
7 mm	2880 kg	39 F 3442



Sangles			
Force	Longueur	Couleur	Référence
600 kg	6 m	noire	39 T 0600
800 kg	8 m	noire	39 T 1800
1500 kg	8 m	jaune	39 T 2801
2550 kg	8 m	verte	39 T 3800



SERRE CABLE
 Ø 4 réf. 39 G 1023
 Ø 6 réf. 39 G 1024
 Ø 8 réf. 39 G 1025

CROCHET à CEIL
 800 kg réf. 39 H 130
 1250 kg réf. 39 H 131
 1600 kg réf. 39 H 132
 2500 kg réf. 39 H 133



R E M O R Q U E S



TREUIL ELECTRIQUES 12 VOLTS



WORKS 1700



WORKS 3700



WORKS 4700



TABOR 9 K



WARN 8000



SERIE SA

Treuil série TW à sangle



SERIE TW

Modèle	Référence	Force non mouflé (daN)	Câble L (m) et Ø (mm)	Puissance moteur (cv)	Poids kg	Dimension L x l x h (mm)
WORKS 1700	40 W 1700	772	11 4	1,6	8	334 x 131 x 162
WORKS 3700	40 W 3700	1680	13 5,5	1,9	15	441 x 117 x 155
WORKS 4700	40 W 4700	2130	18 6,5	1,9	21	452 X 160 X 165
TABOR 9 K	40 T 9 K	4000	30 8	2,1	35	534 x 160 x 193
WARN 8000	40 W 8000	3600	30 8	4,8	34	534 X 160 X 193
SA 5000	40 S 5000	681	6 5		11	254 X 188 X 200
SA 7000	40 S 7000	999	6 5		13	254 X 188 X 200
SA 9000	40 S 9000	1362	7 6		14	289 X 201 X 205
SA 12000	40 S 12000	2043	15 6		16	289 X 201 X 205

Modèle	Référence	Force non mouflé (kg)	Sangle L (m) et l (mm)	Poids kg
TW 4000	40 T 4000	681	6 50	11
TW 9000	40 T 9000	1362	6 50	11

25 R E M O R Q U E S



ACCESSOIRES TREUILS ELECTRIQUES

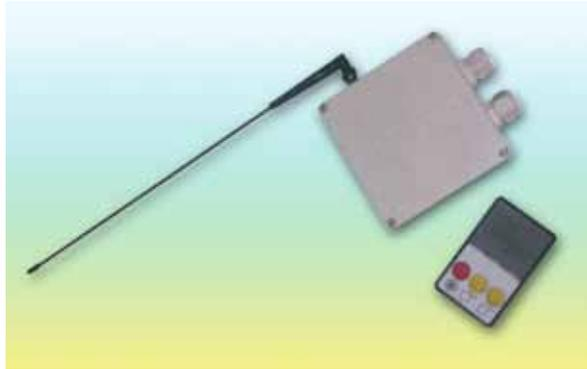

COMMANDE RADIO POUR WORKS
Réf. 40 A 0134



**COMMANDE RADIO
POUR WARM ET TABOR**
Réf. 40 A 0100



**PLATINE STANDARD
FIXATION WARM ET TABOR**
Réf. 40 A 0001



JEU DE PRISES QUICK
Réf. 40 A 0065



CABLE D'ALIMENTATION
35 mm L : 6 m Réf. 40 A 0038



MANILLE CMU 4T750
Réf. 40 A 0103



MOUFLE B 16 POUR CABLE CMR 7200 kg
Réf. 40 A 0015



COFFRE A BATTERIE
Monté sur platine à brider* Réf. 40 A 102
* Préciser section du longeron.

R E M O R Q U E S



SUPPORTS DE TREUIL

PORTE TREUIL SECTION 50 X 50

Hauteur	Remorques	Fixation	Référence
450 mm	210 M à 331 M	60 x 60	39 M 455060
600 mm	210 AB	60 x 60	39 M 605060
	210 PM à 331PM 270 AP à 331 AP		

PORTE TREUIL SECTION 60 X 60

Hauteur	Remorques	Fixation	Référence
450 mm	401 M	60 x 60	39 P 456060
	501 M	80 x 60	39 P 456080
600 mm	401 PM	60 x 60	39 P 606060
	501 PM	80 x 60	39 P 608060



PORTE TREUIL RÉGLABLE BAS 60 X 60 INTERMÉDIAIRE 50 X 50

Hauteur base	Remorques	Fixation	Référence
400 mm	601 M à 851 M	60 x 60	39 G 406060
600 mm	901 M à 1602 M	60 X 60	39 G 606060
	1802 M en larg.1580		

Attention SEMI RIGIDE en ht 450 mm



PORTE TREUIL RÉGLABLE BAS 70 X 70 INTERMÉDIAIRE 60 X 60

Hauteur base	Remorques	Fixation	Référence
700 mm	1802 M en larg.1780 à 2903 M	60 X 60	39 R 707080



27 R E M O R Q U E S



SUPPORTS DE TREUIL



SUPPORT TREUIL A GLISSIERE**
Réf. 39 G 1001



SUPPORT TREUIL 501 RIBSTER
Réf. 39 R 501



SUPPORT TREUIL JET*
Réf. 39 J 30501

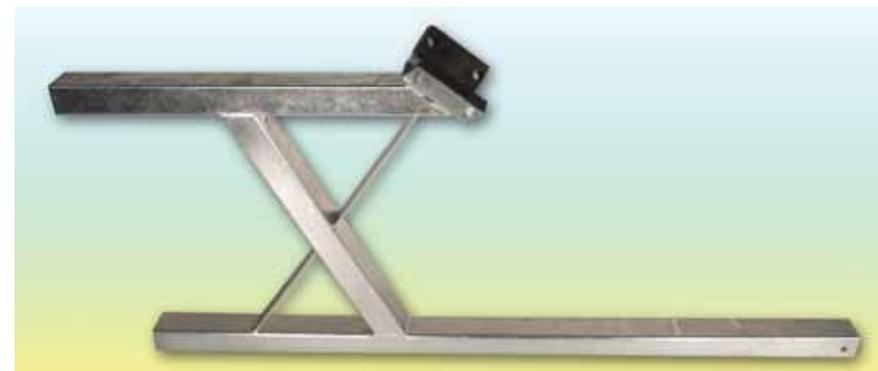

SUPPORT TREUIL SOUDE SPECIAL CAP CAMARAT STYLE

Type de remorque	Référence
651 MFS	39 S 651
851 MFS	39 S 851
1101 MFS	39 S 1101
1301 MFS	39 S 1301

BUTEES



BUTEE REGLABLE
7 trous Lg 480 mm Réf. 39 B 101
9 trous Lg 600 mm Réf. 39 B 102



BUTEE ARTICULEE
Réf. 39 B 200



BOBINE D'ETRAVE***
Réf. 39 B 302

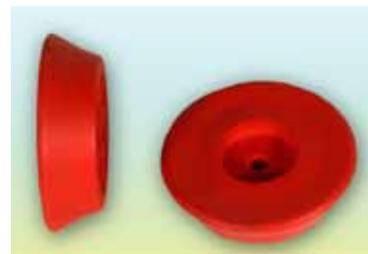

DEMI CONE D'ETRAVE***
Réf. 39 B 303

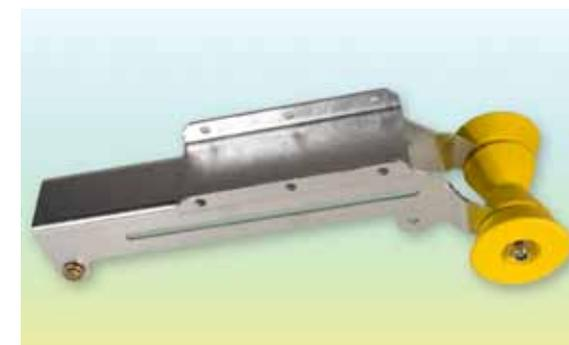

GLISSIERE DE TREUIL
Treuil autofreiné Réf. 39 B 300
Treuil à cliquet Réf. 39 B 301

* Préciser section du timon

** Préciser type remorque et type de treuil

*** Préciser la couleur

ARTICLES CAOUTCHOUC



DIABOLO MINI*
130 X Ø70-40 Réf. 56 D 6030



DIABOLO PN*
200 X Ø70-60 Réf. 56 D 6050



DIABOLO STANDARD*
200 X Ø75-50 Réf. 56 D 6040



DIABOLO SUPER*
200 X Ø86-60 Réf. 56 D 6060



DIABOLO NA 206*
209 X Ø98-62 Réf. 56 D 6070



CONE PN*
Ø180 X 50 Réf. 56 C 06190



GALET PM*
75 X Ø75 Réf. 56 G 06070



GALET GM*
75 X Ø120 Réf. 56 G 06080



GALET BI-MATIERE*
75 X Ø120 Réf. 56 G 06200



PATIN 233**
140 X 60 Réf. 56 A 233

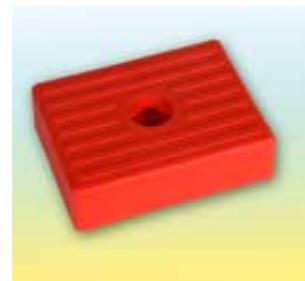

PATIN PM**
130 X 100 Réf. 56 P 07110



PATIN GM**
300 X 100 Réf. 56 P 07120



PATIN GM RENFORCE
300 X 100 Réf. 56 P 07121



PATIN ALVEOLE
30 X 10 au ml Réf. 56 P 07130



PATIN A LEVRE
750 X 90 X 35 Réf. 56 P 07140



PROFIL MC
50 X 15 au ml Réf. 56 P 07150



PROTECTION PORTE MAT
Réf. 56 P 07200



POIGNEE
Ø20 Réf. 56 P 08020
Ø25 Réf. 56 P 08025

* Alésage 21 mm

** Préciser la couleur

29 R E M O R Q U E S



AXES, SUPPORTS ET BALANCIERS

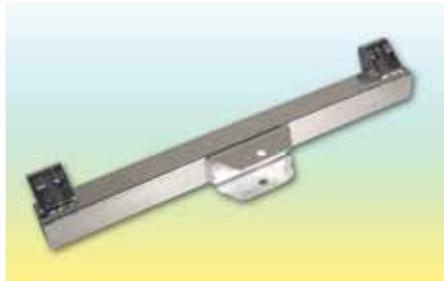

BALANCIER 4 ROULEAUX
Réf. 56 S 104



BALANCIER 6 ROULEAUX
Réf. 56 S 106



BALANCIER 8 ROULEAUX
Réf. 56 S 108



SUPPORT DOUBLE rlx
Pour tube de 30
Réf. 56 S 100



SUPPORT DOUBLE rlx
Pour tube de 40
Réf. 56 S 101



SUPPORT DIABOLO MINI
Réf. 56 S 200



**SUPPORT DIABOLO
STANDARD - PN - SUPER**
Réf. 56 S 201



SUPPORT POUR PATIN 233
Réf. 56 S 300

CLIPS



Référence	Ø en mm
59 C 016	16
59 C 020	20

AXES



Longueur en mm	référence	
	creux	plein
134	56 S 0134	--
170	56 S 0170	--
240	56 S 0240	56 S 1240
320	56 S 0320	56 S 1320



SUPPORT POUR PATIN PM
Réf. 56 S 301



SUPPORT POUR PATIN GM
Réf. 56 S 302



CARDAN DROIT
30 X 30 Réf. 56 S 400
30 X 40 Réf. 56 S 401



CARDAN INVERSE
30 X 30 Réf. 56 S 402
30 X 40 Réf. 56 S 403

ACCESSOIRES MULTIROULEAUX*



ROULEAU BICOLORE SEUL

Ø 80 Réf. 56 F 098
 Ø 90 Réf. 56 F 096
 Ø 100 Réf. 56 F 097



ROULEAU CONIQUE 80X45

Réf. 56 F 095



ROULEAU 60 X 60

Réf. 56 F 093



CÔNE PNEUMATIQUE

Réf. 56 F 094

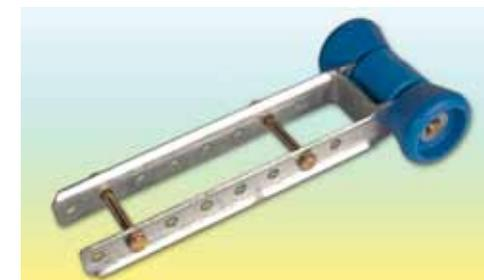

DIABOLO 3 PARTIES SUR PLAT RÉGLABLE

Réf. 56 A 202

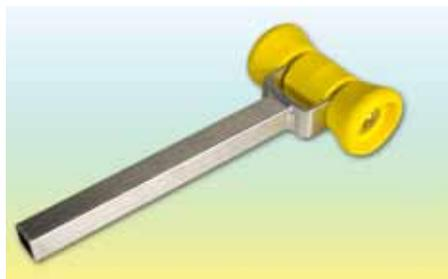

DIABOLO 3 PARTIES SUR CHANDELLE

Réf. 56 A 201



**DOUBLE ROULEAUX
 POUR TUBE 30 X 30**

Ø 80 Réf. 56 F 124
 Ø 90 Réf. 56 F 121
 Ø 100 Réf. 56 F 123



DOUBLE ROULEAUX POUR TUBE 40 X 40

Ø 80 Réf. 56 F 120
 Ø 90 Réf. 56 F 121
 Ø 100 Réf. 56 F 122

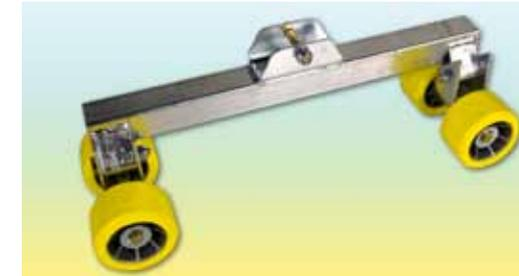

BALANCIER 4 ROULEAUX

Ø 80 Réf. 56 A 480
 Ø 90 Réf. 56 A 490
 Ø 100 Réf. 56 A 4100



BALANCIER 6 ROULEAUX

Ø 80 Réf. 56 A 680
 Ø 90 Réf. 56 A 690
 Ø 100 Réf. 56 A 6100



BALANCIER 8 ROULEAUX

Ø 80 Réf. 56 A 880
 Ø 90 Réf. 56 A 890
 Ø 100 Réf. 56 A 8100



SUPPORT DIABOLO 040

Sur tube 40X40X250
 Réf. 56 A 250
 Sur tube 40X40X400
 Réf. 56 A 400



BARRETTE DE LIAISON

Plate Réf. 56 A 100
 Creuse Réf. 56 A 101



**SUPPORT PATIN
 140 X 60**

Réf. 56 A 1233

* Préciser la couleur

31 R E M O R Q U E S



ACCESSOIRES PNEUMATIQUES



SUPPORT 4 CÔNES*
Réf. 56 P 202



SUPPORT DEMI LUNE
Réf. 56 P 101



RAMPE 16 CONES*
Réf. 56 P 208



RAMPE 20 CONES*
Réf. 56 P 210

ACCESSOIRES BARQUES



SUPPORT DIABOLO SUR PLAT
Largeur 50 Réf. 56 B 010
Largeur 60 Réf. 56 B 011

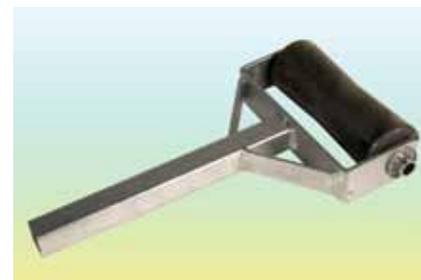

SUPPORT DIABOLO SUR CHANDELLE
Réf. 56 B 012



SUPPORT PATIN EQUERRE
Réf. 56 B 013



RAMPE AQUAPECHE
Réf. 56 B 014



RAMPE SPECIALE BARQUE
Réf. 56 B 015**

ACCESSOIRES BATEAU A QUILLE



BASCULEUR 3 DIABOLOS
Réf. 56 Q 013

RAMPE CM 4 DIABOLOS
Réf. 56 Q 014
Longueur 1630 mm



RAMPE CM 6 DIABOLOS
Réf. 56 Q 016
Longueur 2500 mm



RAMPE CM 7 DIABOLOS
Réf. 56 Q 018
Longueur 3000 mm



* Préciser la couleur ** Préciser l'écartement intérieur des U de fixation

R E M O R Q U E S



32

ACCESSOIRES CATAMARAN

TRAVERSE NUE

60 X 30 X 1800 Réf. 59 C 018



TRAVERSE EQUIPEE DIABOLO + DEMI LUNE*

Réf. 56 C 013



PORTE MAT FIXE**

Réf. 56 C 016



PORTE MAT TELESCOPIQUE**

Réf. 56 C 017



PORTE MAT ARRIERE + FIXATION 60 X 30

Réf. 56 C 018



SUPPORT FLOTTEUR DEMI LUNE

Réf. 56 C 010



SUPPORT FLOTTEUR DIABOLO + PATIN 130

Réf. 56 C 11



SUPPORT FLOTTEUR A L'EQUERRE

Réf. 56 C 012



KIT ETAGE DOUBLE + FIXATION 80 X40

Réf. 56 C 019



LOT DE 4 REHAUSSES TRAVERSE

Réf. 56 C 014



LOT DE 4 BRIDES TRAVERSE

Réf. 56 C 015

ACCESSOIRES JET

RAMPE EASY GLISS***

Réf. 56 J 011



RAMPE BOIS MOQUETTE

Réf. 56 J 012



PATIN EASY GLISS***

Réf. 56 J 010

* Préciser droite ou gauche ** Préciser section du timon *** Préciser la couleur

33 R E M O R Q U E S



ACCESSOIRES DERIVEUR



**SUPPORT SANGLE
AVEC BOULONNERIE***
Réf. 56 D 020



**SANGLE DERIVEUR
11.5 X 200 CM**
Réf. 56 D 021



**SUPPORT QUILLE
2 PATINS ARTICULES**
Réf. 56 D 022



PORTE MAT DERIVEUR EQUIPE DE LA BUTEE
Réf. 56 D 023



BUTEE DE PORTE MAT
Réf. 56 D 024



JEU GUIDES CHARIOT DCH
Réf. 56 D 025



**JEU SANGLE COMPLET
POUR MULTI DERIVEURS**
Réf. 56 D 027



TRAVERSE VERROUILLAGE CHARIOT DCH
Réf. 56 D 026

ACCESSOIRES CANOE ET OPTIMIST



TRAVERSE SUPPORT ECHELLE CANOE *
Réf. 56 K 100



ETAGE CANOE *
Réf. 56 K 101



ETAGE OPTIMIST
Réf. 56 K 102



ECHELLE CANOE
6 Canoës hauteur 2,00 m en 30 x 30 Réf. 56 K 106
8 Canoës hauteur 2,30 m en 60 x 30 Réf. 56 K 108
10 Canoës hauteur 2,70 m en 60 x 30 Réf. 56 K 110

* Préciser la dimension des brides

R E M O R Q U E S



34

ACCESSOIRES SPECIAUX



SUPPORT DOUBLE PATIN 300 X 100
Réf. 56 E 102



SUPPORT SIMPLE PATIN 130 X 100
Réf. 56 E 101



SUPPORT PATIN 300 X 100
Pour tube de 40 Réf. 56 E 103
Pour tube de 50 Réf. 56 E 104

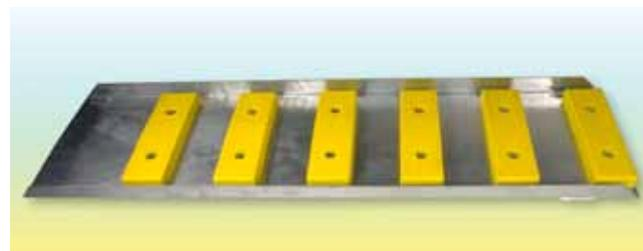

GOUTTIERE VOILIER
1 essieu Réf. 56 E 105
2 essieux Réf. 56 E 106



RAMPE SKI EASY GLISS
Longueur 2800 Réf. 56 E 201
Longueur 3200 Réf. 56 E 202



RAMPE SKI BOIS MOQUETTE
Longueur 3500 Réf. 56 E 203



CHANDELLE SUPPORT RAMPE SKI SOUDEE
Réf. 56 E 204



U SUPPORT RAMPE ARTICULE
Réf. 56 E 205



ENSEMBLE 2 GALETS PM Ø 75
Réf. 56 E 09070



ENSEMBLE 2 GALETS GM Ø 120
Réf. 56 E 09080



ENSEMBLE 4 GALETS GM Ø 120
Réf. 56 E 09084



BALANCIER PN Ø 180 X 55 MM
Réf. 56 B 09190



ENSEMBLE 2 GALETS BI-MATIERE Ø 120
Réf. 56 B 09200



GRENADE ht 300 Ø 40
Réf. 56 E 104

35 R E M O R Q U E S



PIECES D'ASSEMBLAGE

Bride tôle horizontale

Référence	Section tube en mm	Perçage en mm		Référence	Section tube en mm	Perçage en mm
57 T 4101	60 X 30	30-40		57 T 4107	100 X 50	60
57 T 4103	80 X 40	30-40		57 T 4108	150 X 50	30-40
57 T 4104	80 X 40	60		57 T 4109	150 X 50	60
57 T 4105	100 X 40	30-40		57 T 4201	60 X 60	40
57 T 4106	100 X 50	30-40		57 T 4202	80 X 60	30-40

Bride tôle verticale

	Référence	Section tube en mm	Perçage en mm
	57 T 4001	60 X 30	30-40
	57 T 4003	80 X 40	30-40
	57 T 4004	100 X 40	30-40
	57 T 4005	100 X 50	30-40

Oméga 2 trous

Référence	Section tube en mm	
57 T 2001	60 X 30	
57 T 2002	80 X 40	
57 T 2003	100 X 40	
57 T 2004	100 X 50	

U de pivot



CHANDELLES

Chandelles droites	Lg en mm	Référence
30 x 30 x 2	200	57 C 301
	250	57 C 302
	300	57 C 303
	350	57 C 304
	400	57 C 305
	500	57 C 306
40 x 40 x 2	250	57 C 401
	300	57 C 402
	350	57 C 403
	400	57 C 404
	450	57 C 405
	500	57 C 406
	600	57 C 407



Chandelles coudées	Lg en mm	Référence
30 x 30 x 2	590	57 C 501
40 x 40 x 2	590	57 C 502

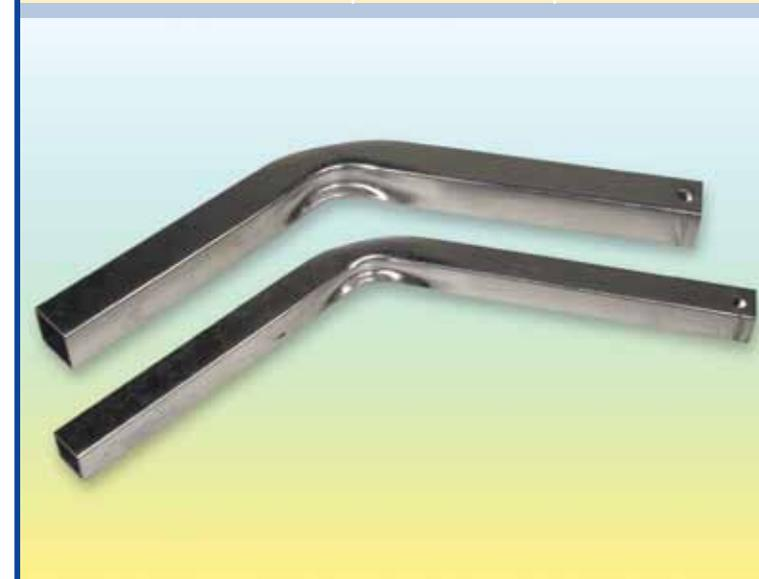



Chandelle réglable
à goupille pour
remorque de chantier
**Référence et tarif
nous consulter**



Chandelle réglable pour voilier
Référence et tarif nous consulter

BRIDES ETIREES

Référence	Diamètre en mm	H x L x H *
57 B 801	8	45 x 32 x 45
57 B 802	8	50 x 36 x 50
57 B 803	8	55 x 42 x 55
57 B 804	8	80 x 62 x 80
57 B 805	8	110 x 54 x 110
57 B 806	8	130 x 54 x 130
57 B 807	8	180 x 54 x 180

Référence	Diamètre en mm	H x L x H *
57 B 1001	10	60 x 42 x 60
57 B 1002	10	70 x 52 x 70
57 B 1003	10	50 x 52 x 50
57 B 1004	10	80 x 62 x 80
57 B 1005	10	80 x 32 x 80
57 B 1006	10	100 x 42 x 100
57 B 1007	10	120 x 52 x 120

Référence	Diamètre en mm	H x L x H *
57 B 1008	10	100 x 62 x 100
57 B 1009	10	60 x 82 x 60
57 B 1010	10	80 x 82 x 80
57 B 1011	10	70 x 102 x 70
57 B 1012	10	75 x 152 x 75
57 B 1202	12	180 x 52 x 180
57 B 1203	12	130 x 52 x 130

* H = Hauteur intérieur, L = Largeur intérieur



Bride carrée

Bride verticale

Bride horizontale

BOUCHONS POUR TUBES



Référence	58B100	58B101	58B102	58B103	58B104	58B105	58B106	58B107	58B108	58B109	58B110
L x l	30x30	35x35	40x40	50x50	60x60	80x60	60x30	80x40	100x40	100x50	150x50



R E M O R Q U E S



38

VISSERIE DIVERS

Boulons

Désignation	Dimension Ø int x Lg
59 V 0830	8 x 30
59 V 0840	8 x 40
59 V 0850	8 x 50
59 V 0860	8 x 60
59 V 08130	8 x 130
59 V 08150	8 x 150
59 V 1030	10 x 30
59 V 1050	10 x 50
59 V 1060	10 x 60
59 V 1080	10 x 80
59 V 1090	10 x 90
59 V 10100	10 x 100
59 V 10110	10 x 110



Désignation	Dimension Ø int x Lg
59 V 1250	12 x 50
59 V 1290	12 x 90
59 V 12110	12 x 110
59 V 12120	12 x 120
59 V 12130	12 x 130
59 V 12140	12 x 140
59 V 12160	12 x 160
59 V 12180	12 x 180
59 V 1430	14 x 30
59 VA 519	Vis d'aile

Rondelles

Désignation	Référence	Dimension Ø int x Ø ext
Rondelle emboutie	59 R 100	9,5 x 34,5
Rondelle L 8	59 R 208	8,4 x 22
Rondelle L 10	59 R 210	10,5 x 27
Rondelle L 12	59 R 212	12,5 x 32
Rondelle éventail Ø 8	59 R 308	--
Rondelle éventail Ø 10	59 R 310	--
Rondelle éventail Ø 12	59 R 312	--
Rondelle éventail Ø 14	59 R 314	--



Ecrous

Désignation	Référence Ø en mm
59 E 109	8
59 E 110	10
59 E 112	12



Molette mâle

Référence	Ø / L
60 RM 830	8 / 30
60 RM 1035	10 / 35



Goupille Béta

Référence	Ø en mm
59 B 003	3
59 B 004	4



R E M O R Q U E S



RECHANGE POUR ATTACHE A INERTIE TYPE "KF"

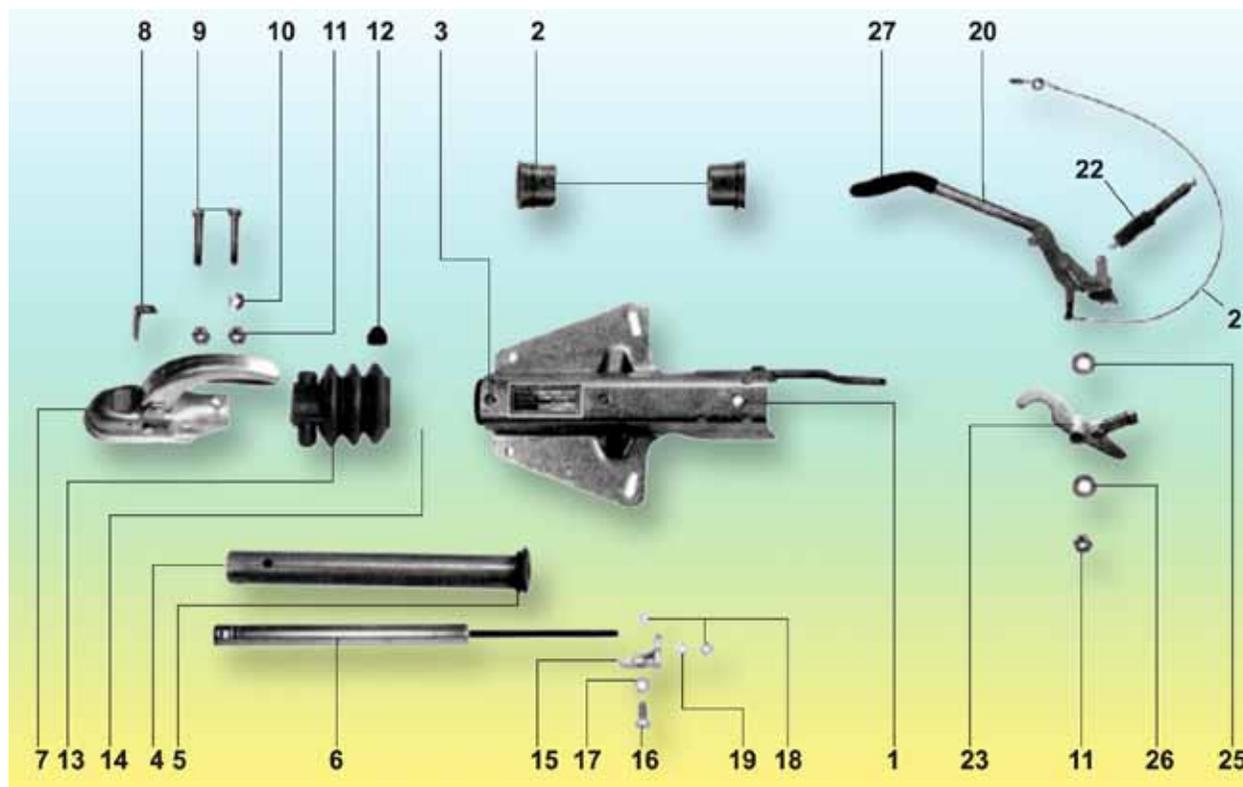

Type attache à inertie	Références							
	Câble de rupture (21)	Tête (7)	Soufflet (13)	Fût coulissant (4)	Amortisseur de tête (6)	Levier de frein (20-21-27)	Amortisseur de levier (22)	Bague de fût (2)
KF7.5 C	20 J 276064	09 N 1200420	20 S 1200455	20 S 1200453	20 C 18	1200499	1200409	1200443
KF 13 C	20 J 276064	09 N 1200420	20 S 1200455	20 S 1200453	20 C 19	1200499	1200409	1200443
KF 20 C	20 J 276064	09 N 1200421	20 S 1200455	20 S 1200453	20 C 20	1200499	1200409	1200443
KF 27 A	20 J 276064	09 N 1200586	20 S 1200455	20 S 1200451	20 C 21	1200500	1200409	1200441
KFG 35 A	20 J 276064	09 N 1200363	20 S 1200458	20 S 1200452	20 C 24	1200502.GF	1200407	--

R E M O R Q U E S



RECHANGE POUR MOYEU 2878534 (4 X 115)

Essieu et fusée 550 kg

Monté sur remorques B-N-R 210 à B-N-R 401

W2878534. KIT

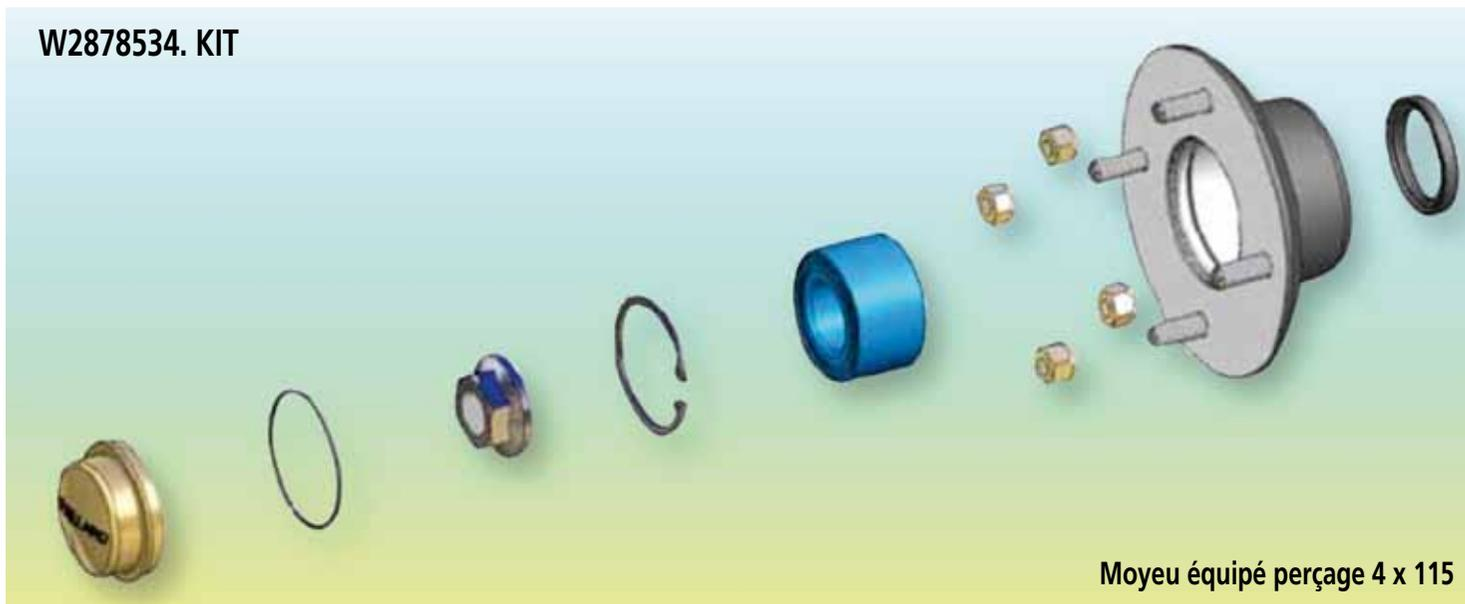

1323017. KIT



1297051



1295004

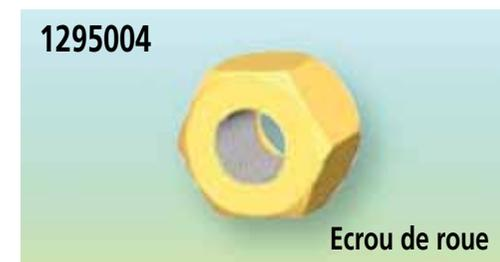

1362024. KIT

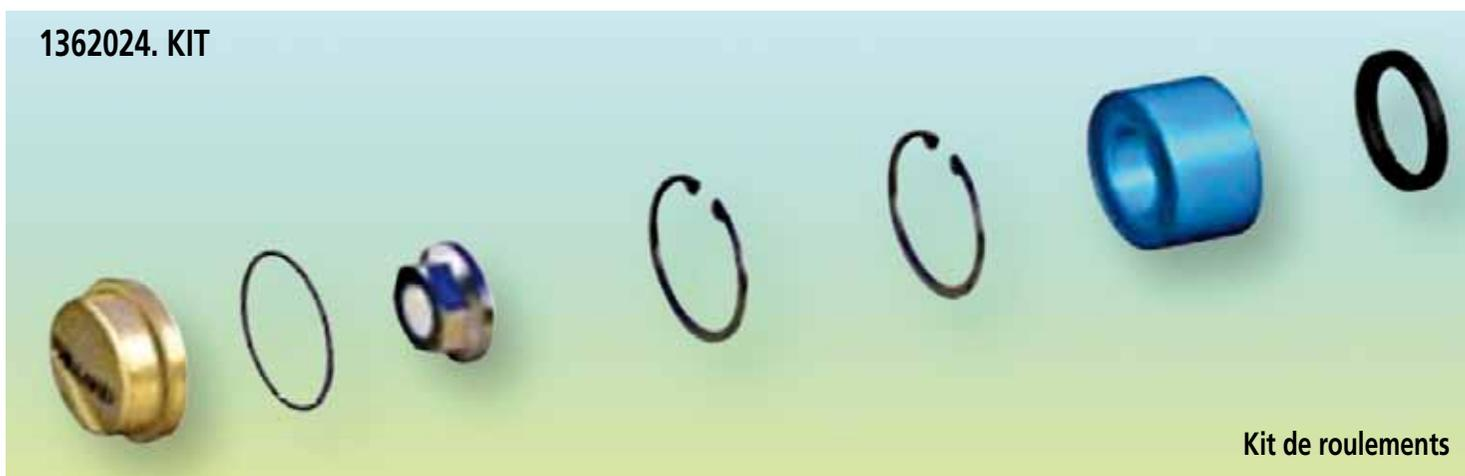

1346437



RECHANGE POUR MOYEU 2878532 (4 X 130)

Essieu et fusée 750 kg

Monté sur remorques B-N-R 501 NF à B-N-R 551 NF

W2878532. KIT

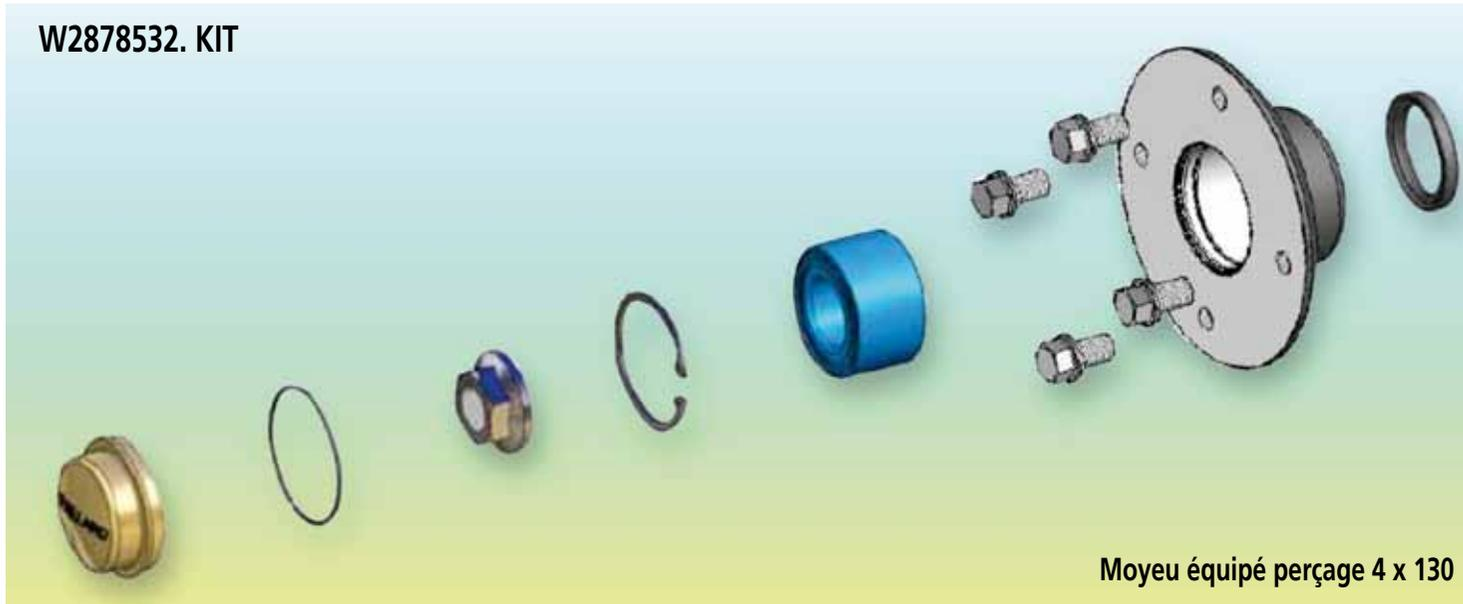

1323017. KIT



1297051



1362024. KIT



1029027



1346437



RECHANGE POUR MOYEU W 3147103 FREIN Ø 200 TYPE R47

Essieu 750 kg / 950 kg / 1350 kg - Fusée Ø 200

Monté sur remorques B-N-R 501 à B-N-R 1001 / N 1101 et N 1181 / B-N-R 1052 à B-N-R 2052 / N 2352 / B-N-R 2903

W3147103. KIT

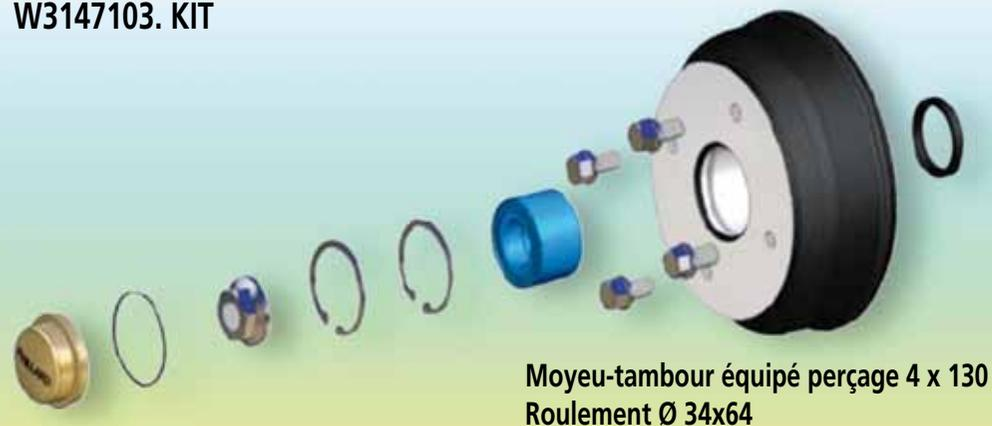

Moyeu-tambour équipé perçage 4 x 130
Roulement Ø 34x64

1007098. KIT

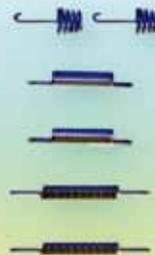

Kit de ressorts
(pour une paire de freins)

1983240

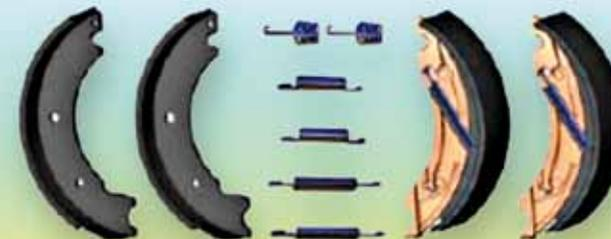

Kit mâchoires de freins (pour une paire de freins)

1362024. KIT



Kit de roulements

1346437



Roulement cartouche
34-64x37

Câble de freins

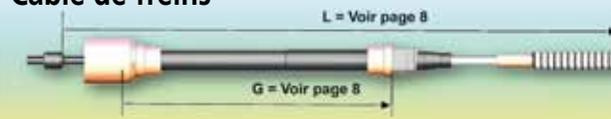

1006072



1/2 coquille arrêt de gaine

1006073



Embout à lumière

1323017. KIT



Bouchon de moyeu D64 + joint

1297051



Ecrou

1029027



Axe de roue M14x1,5

1006071

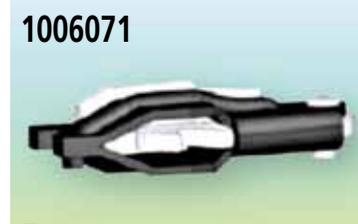

Ecarteur

1006095. KIT



Kit de réglage

RECHANGE POUR MOYEU W 3557502 FREIN Ø 200 TYPE R47

Essieu 1500 kg

Monté sur remorques B-R 1101 à B-R 1181

W3557502. KIT

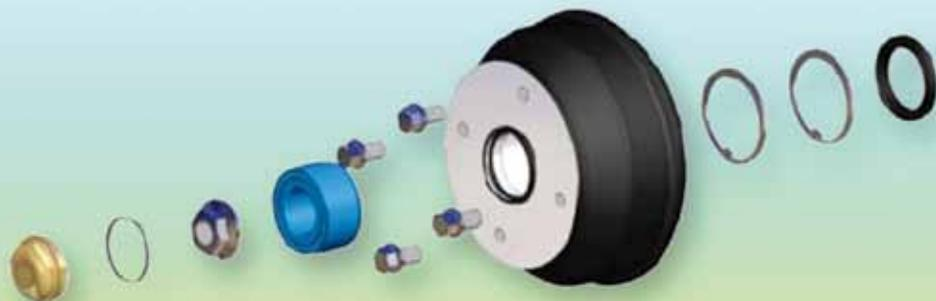

Moyeu-tambour équipé perçage 4 x 130
Roulement Ø 39x72

1007098. KIT

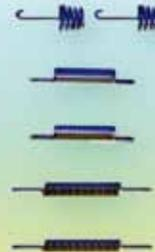

Kit de ressorts
(pour une paire de freins)

1983240



Kit mâchoires de freins (pour une paire de freins)

1362025. KIT

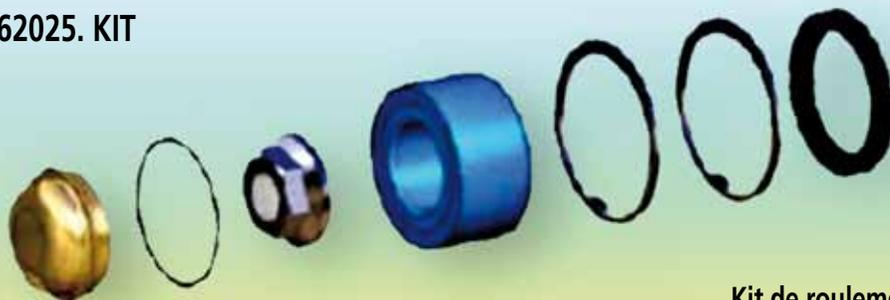

Kit de roulements

1397237

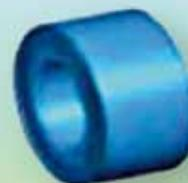

Roulement cartouche
39-72x37

Câble de freins

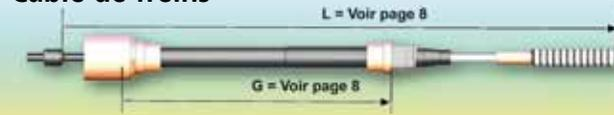

1006072



1/2 coquille arrêt de gaine

1006073



Embout à lumière

1323004. KIT



Bouchon de moyeu D52 + joint

1297051



Ecrou

1029027



Axe de roue M14x1,5

1006071



Ecarteur

1006095. KIT



Kit de réglage

RECHANGE POUR MOYEU W 2914512 FREIN Ø 250 TYPE R40

Essieu 1600 kg / 1800 kg - Fusée Ø 250

Monté sur remorques B-N-R 1301 / B-R 2352 / B-N-R 2552 / B-N-R 2802

W2914512. KIT

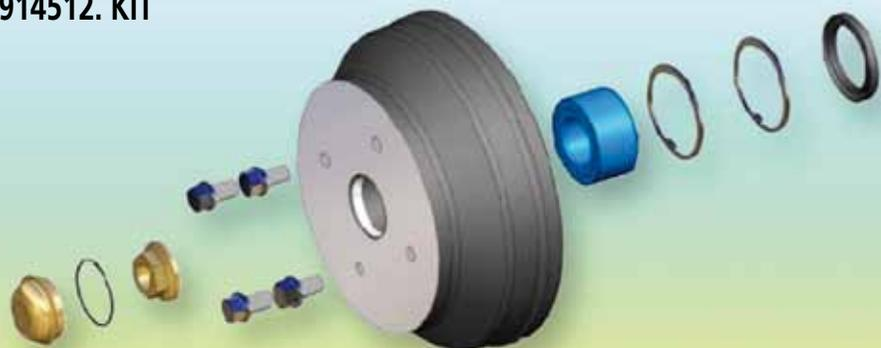

Moyeu-tambour équipé perçage 4 x 130

1007100. KIT

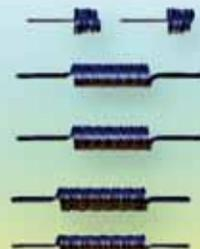

Kit de ressorts
(pour une paire de freins)

2282240

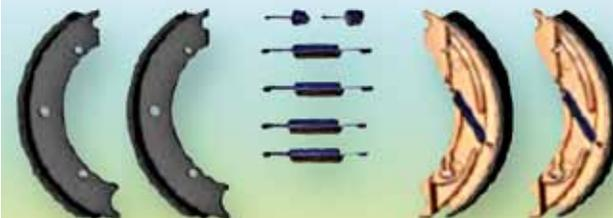

Kit mâchoires de freins (pour une paire de freins)

1362025. KIT

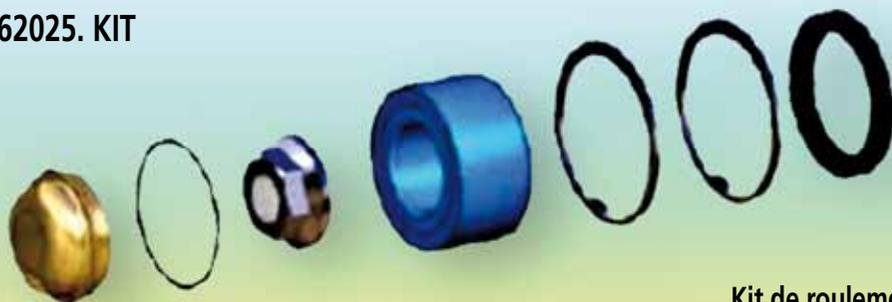

Kit de roulements

1397237



Roulement cartouche
39-72x37

Câble de freins

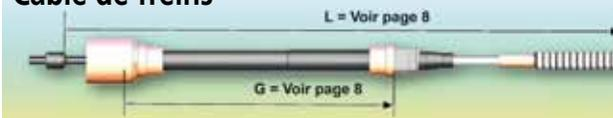

1006072



1/2 coquille arrêt de gaine

1006073

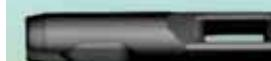

Embout à lumière

1323004. KIT



Bouchon de moyeu D52 + joint

1297051



Ecrou

1029027



Axe de roue M14x1,5

1006071



Ecarteur

1006095. KIT



Kit de réglage

COMPATIBILITE DES RECHANGES POUR ESSIEUX

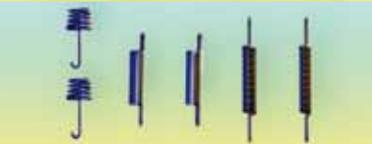
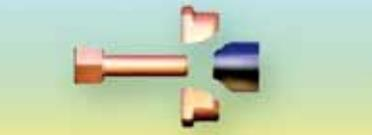
Illustration	Désignation	Référence	Type remorques
	Moyeu NF équipé	W 2878534.kit	B-N-R 210 à 401
		W 2878532.kit	B-N-R 501 et 551
	Moyeu-tambour équipé	W 3147103.kit	B-N-R 501 à 1001 N 1101 et N 1181 B-N-R 1052 à 2052 N 2352 B-N-R 2903
		W 3557502.kit	B-R 1101 et 1181
		W 2914512.kit	B-N-R 1301 B-R 2352 B-N-R 2552 B-N-R 2802
	Kit roulement (pour 1 roue)	1362024.kit	B-N-R 210 à 1001 N 1101 et N 1181 B-N-R 1052 à 2052 N 2352 B-N-R 2903
		1362025.kit	B-N-R 1301 et 2552 et 2802 B-R 1101 et 1181 et 2352
	Roulement cartouche	1346437	B-N-R 210 à 1001 N 1101 et N 1181 B-N-R 1052 à 2052 N 2352 B-N-R 2903
		1397237	B-N-R 1301 et 2552 et 2802 B-R 1101 et 1181 et 2352
	Bouchon de moyeu + joint (pour 1 roue)	1323017.kit	B-N-R 210 à 1001 N 1101 et N 1181 B-N-R 1052 à 2052 N 2352 B-N-R 2903
		1323004.kit	B-N-R 1301 et 2552 et 2802 B-R 1101 et 1181 et 2352
	Kit mâchoires de frein + ressorts (pour 1 essieu)	1983240	B-N-R 501 à 1181 N 2352 B-N-R 1052 à 2052 B-N-R 2903
		2282240	B-N-R 1301 B-R 2352 B-N-R 2552 B-N-R 2802
	Kit de ressort (pour 1 essieu)	1007098.kit	B-N-R 501 à 1181 N 2352 B-N-R 1052 à 2052 B-N-R 2903
		1007100.kit	B-N-R 1301 B-R 2352 B-N-R 2552 B-N-R 2802
	Kit de réglage (pour 1 roue)	1006095.kit	B-N-R 501 à 1181 N 2352 B-N-R 1052 à 2052 B-N-R 2903
		1006096.kit	B-N-R 1301 B-R 2352 B-N-R 2552 B-N-R 2802

BATTERIES MIDAC-SEREMO ENERGECO

Batterie de démarrage / semi-traction

GAMME XTRA

Sans entretien dotée du nouveau système de sécurité
M.A.SS inclinaison 45°



Réf	Ampères
XL1	55
XL2	62
XL3	70
XL4	80
XL5	100

Batterie marine étanche permettent une inclinaison à 45° fort ampérage EN Pour exemple 70 ampère = 540 ampère EN la batterie MIDAC hermeticum est dotée d'un double couvercle avec labyrinthe termo-soudé.Elle est fabriquée par un processus qui ont permis à Midac d'être certifié ISO/TS/16949.

Batterie de traction

GAMME EW

Batterie permettant 600 cycles selon DIN 40757
pour moteur électrique



Réf	Ampères
EW75	75
EW100	100

Batterie à décharge lente pour moteur électrique Permet 600 cycles de décharge recharge selon DIN 43 757

R E M O R Q U E S



47

SA A.I.N.

**8, Rue Denis Papin
53400 CRAON**

Tél. : 02 43 06 99 96

Fax : 02 43 06 99 99

e-mail : sav.pam@live.fr

R E M O R Q U E S

